

# Business Catalog by Japanese Companies for Decarbonization Realization in Indonesia (9<sup>th</sup> Edition)

*“71 Decarbonization Solutions  
toward Net Zero”*

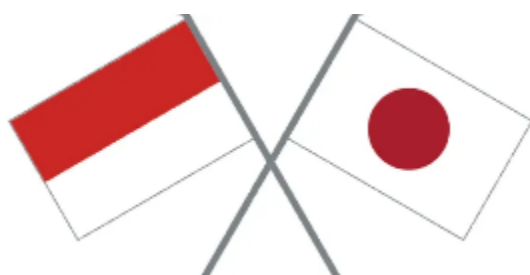

February 2024  
JETRO Jakarta Office

**JETRO**

Japan External Trade Organization

# Introduction

The Indonesian government has an aim to cut greenhouse effect gas by 43.20% with International support and 31.89% without International support until 2030. In addition, in July 2021 there was a presentation of [Indonesia's long-term strategy 2050 toward low carbon and climate resilience] and an announcement of carbon neutral accomplishment target until 2060. Meanwhile there is a possibility of energy demand increase in Indonesia following the economic development hereafter, moreover a high chance of continual dependency level to coal and natural gas as a start of fossil fuel that takes an account for energy support, there is a lot of tasks to achieve carbon neutral.

As the Japanese government is processing support regarding each ASEAN country's decarbonization including Indonesia, an Asia energy transition initiative (AETI) was proposed by the Ministry of economy, trade, and industry in May 2021. Furthermore, to achieve the target of carbon neutral, Indonesian government also makes an initiative such as conducting carbon tax on coal-fired power plants.

As JETRO, processing information sharing related to the Japanese government and Indonesian government's policy for Japanese company investment facilitation in carbon neutral field.

Until now Japanese companies in Indonesia have made an excessive effort toward solar power and so forth renewable energy conduct, carbon dioxide collection, use and storage (CCUS), vehicle electrification et cetera, which is raising the expectation from the Indonesian side to Japanese companies.

This business catalog is an introduction to business which can contribute to emission reduction in industrial activities in Indonesia according to Japanese companies. By using this document, each company's industrial activities can be expected to go toward decarbonization.

JETRO Jakarta Office

This business catalog is an introduction to business which can contribute to emission reduction in industrial activities in Indonesia according to Japanese companies.

## Table of contents

<b>1. Renewable Energy (Solar, Hydro, Geothermal)</b>	<b>.. 4</b>
<b>2. Biomass/Waste Power Generation</b>	<b>..15</b>
<b>3. Decarbonization of Fossil Fuels, CCUS/Carbon recycling</b>	<b>..27</b>
<b>4. Electrification of Vehicles, Battery</b>	<b>..34</b>
<b>5. Energy Conservation</b>	<b>..38</b>
<b>6. Utilization of digital technology</b>	<b>..51</b>
<b>7. Effective Use/Conservation of Resources</b>	<b>..60</b>
<b>8. Agriculture and Forestry Sector</b>	<b>..65</b>
<b>9. Finance/Insurance etc.</b>	<b>..69</b>
<b>10. Transportation</b>	<b>..73</b>
<b>11. Strategy formulation and consulting for decarbonization</b>	<b>..77</b>
<b>12. Comprehensive Solution to Decarbonization</b>	<b>.. 83</b>
<b>[Reference]</b>	
<b>Map of Decarbonization Efforts by Japanese</b>	<b>..87</b>

# 1. Renewable Energy (Solar, Hydro, Geothermal)

- **Onsite solar power generation equipment rental**  
(PT. Sojitz Indonesia)
- **Solar Power Rental** (Alam Energy by Shizen Energy Group)
- **B2B Solar Distributed Generation** (PT. Nippon Oil Indonesia)
- **On-site Solar PV Leasing**  
(Mitsui & Co., Ltd./PT Xurya Daya Indonesia (“Xurya”))
- **Solar System Installer (EPC)** (PT. Quint Solar Indonesia)
- **EBLOX/Triple Hybrid Generation System**  
(PT. MHI ENGINE SYSTEM INDONESIA)
- **Hydroelectric Plant IPP Project** (NiX JAPAN Co., Ltd.)
- **IoT Solution for Reducing Problem at Geothermal Power Plant**  
(PT. Toshiba Asia Pacific Indonesia)
- **Comprehensive Service for Geothermal Power Plants**  
(TOYO Engineering Corporation)
- **Products for the Renewable Energy Market (Solar and Geothermal)** (PT. Furukawa Electric Indonesia)



# With zero cost initial investment, green electric power installation is possible

## Onsite solar power generation equipment rental

### PT. Sojitz Indonesia

#### Product and service outline

- ▶ PT. Surya Nippon Nusantara (“SNN”), a joint venture between Sojitz and SUN Energy (“SUN”), the largest rooftop solar developer in Indonesia, aims to provide decarbonized energy solutions including rooftop solar PV system to industrial and commercial customers in Indonesia.
- ▶ Our service includes an entire process from engineering, procurement, construction and O&M, as well as support for obtaining permits and licenses. Customers can achieve reductions in GHG emissions and lower electricity costs without any initial investment and maintenance burden during operation.
- ▶ Through an industrial park in Bekasi (Deltamas/GIIC), Sojitz is committed to the long-term development of the industry in Indonesia. Together with SUN who has the most extensive track record of rooftop solar PV system in Indonesia, we provide most stable and high-quality services to our customers through long-term contracts.
- ▶ If you are interested in implementing decarbonized energy solutions such as onsite rooftop solar PV system and green electricity use, please reach our contact person as mentioned below.

#### Actual result and example

##### [Sojitz group renewable energy project]

- Sojitz group has developed and participated in many power plant projects globally in which renewable energy power plant is about 2GW in total.
- As for solar, we have owned and managed 12 power plants in Japan with a total of 284MW, and 4 projects in overseas with a total of 700MW. In addition, we have also owned, managed, and developed 116MW domestic, 872MW overseas wind power plants, and 75MW domestic biomass power plant.

##### [Onsite solar installation actual result in Indonesia]

\*Followings are the track record of our partner, SUN.

- Global consumer product manufacturer (200kWp)
- Japanese automotive manufacturer (1,900kWp)
- Local group shopping mall (2,000kWp)
- and others. (at the end of 2023, the total installed capacity is more than 70MWp)

Indonesia: Onsite solar



#### Contact point

PT Sojitz Indonesia

Mamoru Suzuka: +62-(0)811-1923-8137 [suzuka.mamoru@sojitz.com](mailto:suzuka.mamoru@sojitz.com)

Reza Rachmanda: +62-(0)811-1903-8214 [reza.rachmanda@sojitz.com](mailto:reza.rachmanda@sojitz.com)

# Ready to start decarbonization measure Solar Power Generation Rental

## Alam Energy by Shizen Energy Group



### Product and Service Outline

- ▶ Mainly offering solar power generation equipment rental service toward industrial customers such as manufacturing industry and business facilities. Customers don't need to bear by themselves the solar power generation system establishment cost, green electric power can be procured for long term without initial investment. It can be called [third party ownership model], the operation and maintenance management during the contract will be carried out by our company. In addition to the contribution to the decarbonization target, it will also contribute to electric utility expense reduction which is assumed to be rising hereafter.
- ▶ As for the plan and construction, our company will assign our onsite contractor quality control, and we also will handle the technology standard completion from the customer's main office, so leave it to our company with no concern. During the term of the contract, proper management operations also will be performed.
- ▶ In addition, a solution comprising 100% renewable energy of used electric power for application of the Joint Crediting Mechanism (JCM) of the Ministry of the Environment (Japan), resilience enhancement through battery storage installation, and renewable energy certificate (I-REC) will be offered comprehensively.

### Actual Result and Example

PT ATW Alam Hijau has owned the installation actual result of solar power generation equipment for each place in West Java, East Java, Bali island, and Batam island.

<Construction complete actual result>

1.22 MWp	West Java	Pharmaceutical company factory
0.46 MWp	West Java	Pharmaceutical company factory
1.20 MWp	East Java	Wood processing plant
0.54 MWp	East Java	Wood processing plant
0.47 MWp	Bali Island	Car dealer (several stores)
0.36 MWp	Batam Island	Car dealer (several stores)
0.31 MWp	East Java	Steel pipe factory
0.66 MWp	East Java	Steel pipe factory
0.22 MWp	West Java	Power plant
0.81 MWp	West Java	Pharmaceutical company delivery center

<Installation schedule (July 2022) >

Paper industry, daily necessities, and packaging manufacturer (all in West Java)



### Contact Us:

Japanese : Nishimori Soichiro: +81 80 33160833 [soichiro.nishimori@alamport.com](mailto:soichiro.nishimori@alamport.com)  
Ogawa Ryo: +81 90 65673712 [ryo.ogawa@shizenenergy.net](mailto:ryo.ogawa@shizenenergy.net)  
Bahasa : Jessica Rolindrawan: +62 812 85763736 [jessica.rolindrawan@alamport.com](mailto:jessica.rolindrawan@alamport.com)



## B2B Solar Distributed Generation

### PT. Nippon Oil Indonesia

#### Our Product and Service Overview

- ▶ Our company is collaborating with TotalEnergies, a global energy company, and start Independent Rooftop Solar Power Generation business support in Asia (※)
  - ※ Japan, Indonesia, India, Thailand, Vietnam, Philippines, Cambodia, Singapore, Malaysia
- ▶ To realize reduction of customer's electricity costs and supply of low-carbon energy by installing rooftop power generation equipment on the premises and facilities (factories, warehouses) at zero initial cost for corporate customers.
- ▶ Taking advantage of achievements and foundation as experienced energy companies, ENEOS & TotalEnergies support steady supply of Renewable Energy.
- ▶ Similar proposal can be implemented for countries (※) outside Indonesia, where this business is being developed.

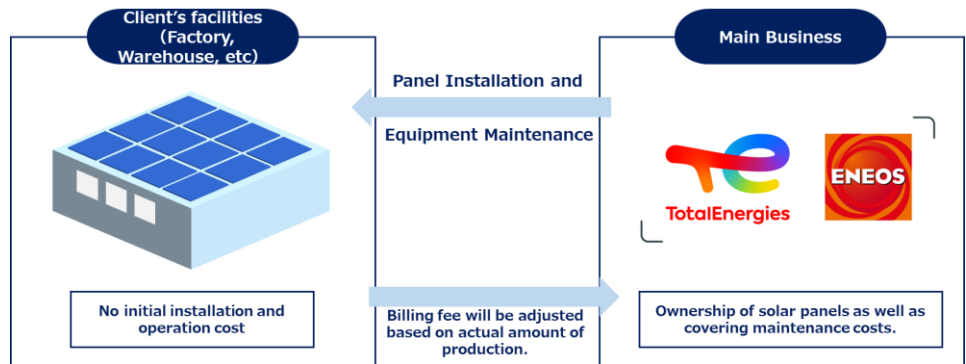

#### Our Portfolio and Clients

- ENEOS Group has developed distributed solar power generation project for gas stations and factories in Japan. In collaboration with TotalEnergies, we are starting to develop projects outside Japan.
  - TotalEnergies own 2GW of power generation capacity in distributed solar power generation business with extensive experiences in Asia.
- <Solar Power Generation Business Support Project in Indonesia>

※ Some example of our partner's, TotalEnergies, clients

- Petrochemical Factory Capacity 1,200 kWp
- Food Processing Factory Capacity 6,800 kWp
- Manufacturing Capacity 4,800 kWp and many others.



#### Contact Us:

PT. Nippon Oil Indonesia

- Miwa (Japanese/English)

Telp : +62-811-993-6685

E-mail : [j.miwa@noid.jx-group.co.id](mailto:j.miwa@noid.jx-group.co.id)

- Martin (English/Bahasa Indonesia)

Telp : +62-811-199-9238

E-mail : [martin@noid.jx-group.co.id](mailto:martin@noid.jx-group.co.id)

# On-site Solar PV Leasing

Installation of Solar PV System on Customer Roofs at Zero Initial Cost

## Mitsui & Co., Ltd. / PT Xurya Daya Indonesia ("Xurya")

### Product and Service Outline

- ▶ Xurya provides development, operation and maintenance ("O&M") services for solar installations for industrial and commercial customers in Indonesia. Xurya offers on-site solar power installations in a lease format with no initial investment and no O&M cost burden for customers.
- ▶ In October 2022, Mitsui invested in Xurya (see [Mitsui Topics](#)). Mitsui, as a shareholder of Xurya, will support and promote Xurya's on-site solar power generation business by leveraging its knowledge of distributed solar power business cultivated in countries around the world and through its network in Indonesia and abroad.
- ▶ If you are interested in installation of on-site solar power generation to reduce CO<sub>2</sub> emissions and electricity cost, please contact us at the contact information below.

### Actual Result and Example

#### Mitsui Group's Renewable Energy Business

- As of September 30, 2022, Mitsui is involved in 2.6 GW of renewable energy projects including hydroelectric power generation (Mitsui's net capacity) of which Mitsui owns over 0.7 GW of solar assets.
- Mitsui is involved in distributed solar projects in the U.S. and other countries around the world.

#### Xurya's track record in On-Site Solar Power

- Established in 2018. Xurya is a leading company and a first mover in Indonesian on-site solar market.
- With a total of over 70 sites for small, medium, and large companies, including textile and food manufacturers, including Japanese companies, and will continue to meet the needs of C&I customers in Indonesia, which is expected to grow in the future.

<Xurya's awarded capacity>

As of the end of Oct 2022, more than 90 MWp

<Project case examples>

Japanese consumer goods manufacturer (6.0 MWp)

Japanese auto parts manufacturer (3.2 MWp)

National ceramics manufacturer (5.6 MWp), etc.

Site at Center of Jakarta City



Site at a Japanese Manufacturing Company



Xurya as 1<sup>st</sup> top Green & RE startup in G20 Event



### Contact Us:

Japanese, English : Mitsuko Ohsedo : +81-80-5461-8403

: Hirofumi Orito : +62-21-2985-6250

Bahasa : Surya Irawan Sukma : +62-21-2985-6258

[M.Ohsedo@mitsui.com](mailto:M.Ohsedo@mitsui.com)

[H.Orito@mitsui.com](mailto:H.Orito@mitsui.com)

[I.Surya@mitsui.com](mailto:I.Surya@mitsui.com)

# Solar System Installer (EPC)

Using Original Light Weight Panel Without Bolt and Screw on Your Roof

## PT. Quint Solar Indonesia

### Product and service outline

- ▶ Rooftop solar system installation work and maintenance service
- ▶ Ground installation solar system installation work and maintenance service
- ▶ Floating solar system installation work and maintenance service
- ▶ Farming type solar system installation work and maintenance service
- ▶ Target area: Entire Indonesia
- ▶ 365 days x 24 hours monitoring service center
- ▶ Utilizes the original solar panel installation method that does not use bolts or screws on the roof

### Actual result and example

- PT. Pigeon Indonesia
- Papaya Super Surabaya Darmo
- Papaya Super Surabaya Pakuwon
- Papaya Super Bali Kuta
- Papaya Bekasi
- PT. Meiji Indonesian Pharmaceutical Industries
- PT. Kao Chemical Indonesia
- PT. Yamaha Indonesia Motor Manufacturing
- PT. Katolec Indonesia
- University Indonesia

PT Yamaha Indonesia Motor Manufacturing  
(Roof Top 1330KW)



University Indonesia (Floating solar 12KW )

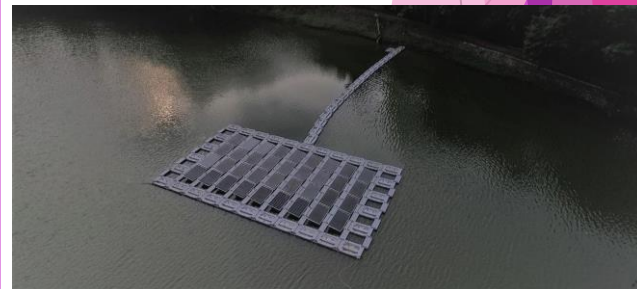

### Contact Us:

PT. Quint Solar Indonesia (Mrs. Vina: English and Bahasa support)

—Phone number : +62 811-9211-692

—E-mail address : [info@quintsolar.co.id](mailto:info@quintsolar.co.id)



# EBLOX/Triple Hybrid Generation System

Stable and Maximum Use of Solar

## PT. MHI ENGINE SYSTEM INDONESIA

### Product and Service Outline

- ▶ Under the circumstances where decarbonization efforts are required worldwide, all companies were being required not only setting their target, but also establishing a practical plan and its verification. Other than short term solution such as Renewable Energy Certificates (REC), we propose you to install EBLOX triple hybrid generation system to stabilize your power generator while your company maximize the utilization of solar power plant that is not stable as a sustainable and developmental solution to achieve low carbon operation in the company.
- ▶ Compared with Japan and other Southeast Asian countries, Indonesian electricity supply is still dependent on low efficient and carbon intensive coal-fired power plants. Therefore, CO<sub>2</sub> reduction by the installation of EBLOX triple hybrid generation system in Indonesia is significantly larger than other countries. Furthermore, there is an opportunity to utilize the Joint Crediting Mechanism (JCM) subsidy by the Ministry of Environment of Japan.
- ▶ EBLOX system can control automatically three kinds of energy sources such as solar power, engine, and storage battery, and aiming for the maximization of the solar power plant. EBLOX engine will stabilize the power electricity supply at bad weather and night. On the other hand, because the voltage frequency of solar power plant is not stable, the storage battery will stabilize it. MHI is also using the technology of VSG (Virtual Synchronous Generator). In the future, through replacing component to hydrogen engine may creates carbon negative. Because the power plant can operate independently, this will contribute to Business Continuity Plan(BCP) of the users.

### Achievements and Examples

- EBLOX was awarded by Cogen Award in 2021 in Japan.
- Engine can be either diesel engine or gas engine. Gas engine is expected to contribute to much higher efficiency and CO<sub>2</sub> reduction with cogeneration utilizing waste heat.
- The reliability of Eblox system has been verified through demonstration facility in Japan and overseas. We can provide a simulation test of the factory load in advance.
- Engines are manufactured in Japan. And in the past 30 years we have delivered more than 3,000 units in Indonesia, and we also provide the best after sales service.
- EBLOX is capable for sound operation under both 1) On-grid operation and parallel operation with other generators, and 2) Off-grid operation in remote area or in case of disasters.
- By reflecting weather forecasts and/or factory demand forecasts using MHI AI cloud system, you can expect more efficient battery operation (charge/discharge).
- Remote monitoring is available and make it easy for users to monitor the systems in multiple locations from office and labor saving.
- Depend on our customer demand, site, and their target of CO<sub>2</sub> reduction, we will verify the number of units and the size of each solar power, engine, and storage battery, then we will propose the suitable detail for our customer.

### Demonstration & Verification Plant in Japan

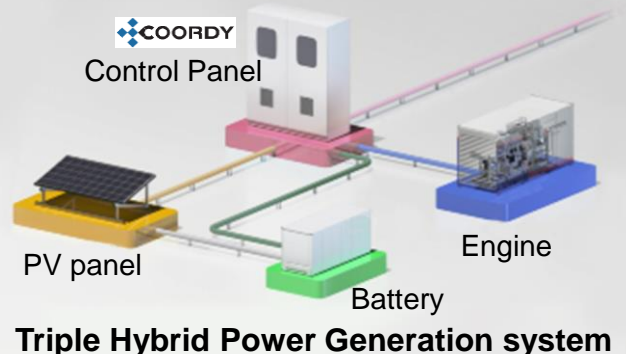

### Contact point

PT. MHI Engine System Indonesia (Mr. Joko Nugroho and Mr. M.Muaz Afra Y English and Bahasa support)

—Phone number : +62-21-789-0191

—E-mail address : [joko.nugroho.sr@mhi.com](mailto:joko.nugroho.sr@mhi.com) & [muaz.afra.8y@mhi.com](mailto:muaz.afra.8y@mhi.com)

# Hydro power plant IPP project

NiX JAPAN Co., Ltd.

## Product and Service Outline

- ▶ Our company is not only in Japan but also carrying out hydro power IPP project in Indonesia, about the Tongar hydro power IPP project, NiX group Indonesia subsidiary corporation PT. NiX Indonesia Consulting (NIC) and NiX JAPAN Co., Ltd. (NiX) are performing below service;
  - Engineering: FS, Planning, Design, Construction management
  - Finance: Fund raising, Investment
  - Commercial: JV partner discover, JV establishment, License
- ▶ Even for the design and construction stage in this place which is a high-risk project, the construction DX such as BIM/CIM technology has taken in actively, while using 3D, 4D model the system is arranged to be able to do construction management on the site where the design and construction performed or even with remote work, such as managing the construction progress from 4 points that are the actual site, Jakarta office, Japan main office, and work from home staff, and by performing EPC management, construction quality management NiX group owners engineering, can measure the project cost reduction, risk reduction, and can manage a high-quality project.
- ▶ Moreover, this project can contribute to greenhouse gas (GHG) emission amount reduction due to application of the Joint Crediting Mechanism (JCM) of the Ministry of the Environment (Japan), offering solutions toward ESG management such as contribution in Japan and Indonesia renewable energy installation and expansion.

## Tongar hydro power plant Specification

Location	Padang, Sumatra island
Subject	Tongar river
Power Generation Output	6.2MW
Power Generation Form	Run of river Design flow rate 16m <sup>3</sup> /s Effective fall distance 44.4m
Equipment	3.1MW (horizontal axis Francis turbine) × 2 unit
Selling Electricity Amount for a Year	38.73GWh (equal to 46,000 units standard house in Indonesia)

## Actual Result and Example

- NiX was established in 1979, performing infrastructure engineering service, domestic and overseas IPP business as the mainline project, and taking form as the NiX group with 15 companies domestic and overseas country including the special purpose company. About the power generation project, the small hydro power project initiative started in 2010 in Japan, and at present has owned actual results of more than 50 hydro power equipment designs. As the IPP developer, managing 3 spots of our company's small hydro power plants in Toyama prefecture and Ishikawa prefecture. In April 2019, we are making the best use of experience cultivated in Japan for the overseas project, establishing PT. NiX Indonesia Consulting as the local corporation in Jakarta, for strengthening the overseas hydro power project such as construction management, technology consideration, and development in Indonesia. Tongar hydro power plant, which was developed in West Sumatra Province, has begin commercial operation in November 2023. In order to further expand hydropower business overseas, Ketaun hydro power plant (13,000kW) is currently under development in Lebong Regency, Bengkulu Province. Now we are proceeding to conclude a PPA (power purchase agreement).
- < Actual result of power plant in Japan >
- Hiraso river small hydro power plant 2015 Ishikawa prefecture
  - Yudani river small hydro power plant 2018 Toyama prefecture
  - Kanazawa yuwaku small hydro power plant 2022 Ishikawa prefecture
- < Overseas in-house power plant results >
- Under operation: Tongar hydro power plant 2023 West Sumatra 6,200kW
- < Overseas in-house power plant project >
- Under development: Ketaun hydro power plant, Bengkulu Province, 13,000kW

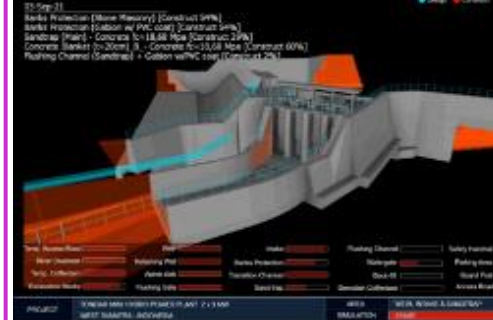

## Contact Us:

NiX JAPAN Co., Ltd., Oversea project supervision, Yoshio Wataru  
 —Phone number: +81-76-464-6520 / +81-80-2957-3801  
 —E-mail address: [w.yoshio@nix-japan.co.jp](mailto:w.yoshio@nix-japan.co.jp)

# IoT Solution for Reducing Problem at Geothermal Power Plant

Contributes to decarbonization by preventing unexpected troubles with predictive failure diagnosis technology and supports from Toshiba local subsidiary in Indonesia

## Toshiba Energy Systems & Solutions Corporation(TESSC) PT. Toshiba Asia Pacific Indonesia(TAPI)

### Product and Service Outline

- ▶ We offer IoT service which uses IoT and AI technologies, including predictive failure diagnosis and performance monitoring. This service aims at improving the utilization rate of the power generation facilities at geothermal power plant which is decarbonized power supply.
- ▶ This system is distinguished technologically by its use of AI to analyze real-time power plant operation data obtained from various sensors and detect signs of anomalies that may cause problems during normal operation. In doing so, it reduces the number and duration of power plant shutdowns; a demonstration project conducted by NEDO (New Energy and Industrial Technology Development Organization) showed that it was able to reduce the rate at which problems occurred by over 20%. Another significant feature is the ability to detect signs of anomalies under conditions specific to geothermal power plants, such as the unstable condition of the steam flowing into the turbine, which is not the case with thermal power plants.
- ▶ This system can be used for consideration of preventing problems by analyzing real-time power plant operation data at plant and by sharing analysis results between customer, TESSC and each location in Indonesia through information technology.
- ▶ Engineers of our local subsidiary in Indonesia, PT. Toshiba Asia Pacific Indonesia (TAPI), share the trouble information and support customers with speedy resolution, regular inspection, periodical inspection and daily maintenance.

### Actual Result and Example

- We have concluded a IoT service contract with Indonesia's PT Geo Dipa Energi (Persero) which includes predictive failure diagnosis and performance monitoring at plant.
- This service represents a commercial version of what has been implemented as a NEDO demonstration project for this power plant in October 2019\*. The demonstration project verified the effectiveness of the company's IoT-based predictive failure diagnosis technology and helped with the contract's conclusion. The system provided through this service employs EtaPRO™, a software suite acquired by Toshiba ESS last year.
- EtaPRO™ is a Plant monitoring software for power generation operators that has been installed for more than 30 years at power plants in 60+ countries with an approximate total capacity of 700 GW, including thermal, hydro, wind, and solar plants.
- We will be proactive in proposing the IoT solutions that enable optimal operation that will help to solve issues faced by individual current and future customers.

\*: NEDO (New Energy and industrial Technology Development Organization) "Research and Development of Geothermal Energy Generation Technologies"

EtaPRO™ Predictive Failure Diagnosis Overview

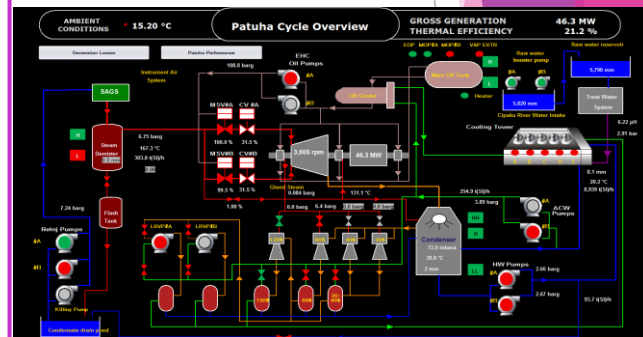

Remote monitoring utilizing predictive failure diagnosis

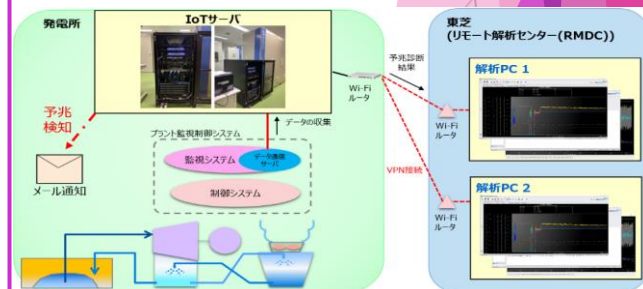

### Contact Us:

PT. Toshiba Asia Pacific Indonesia (Mr. Agung Pratomo Subagio: English and Bahasa support)

—Phone number: +62-813-1757-1957

—E-mail address: [agung\\_pratomo\\_subagio@tasia.toshiba.co.jp](mailto:agung_pratomo_subagio@tasia.toshiba.co.jp)



# Comprehensive Service for Geothermal Power Plants

## TOYO Engineering Corporation

### Product and Service Outline

- ▶ TOYO Engineering Corporation provides comprehensive service related to the development, operation and maintenance of geothermal power plants.
- ▶ PT Inti Karya Persada Teknik (IKPT), an Indonesian affiliate, carries out the Engineering, Procurement and Construction (EPC) for geothermal power plants in Indonesia.
- ▶ TOYO provides services for additional geothermal development using "Geothermal Closed Loop". "Geothermal Closed Loop" is the system that circulates fluid from above the ground in pipes installed underground, recovering energy from underground heat sources without taking out fluid from underground. The system enables geothermal development only using a heat source. It has major environmental advantages such as preventing the depletion of hot springs, as well as the cost advantages like repurposing the abated old wells.
- ▶ TOYO provides downhole monitoring by optical fiber, and remote monitoring service that combines its plant operation support service, DX-PLANT®.

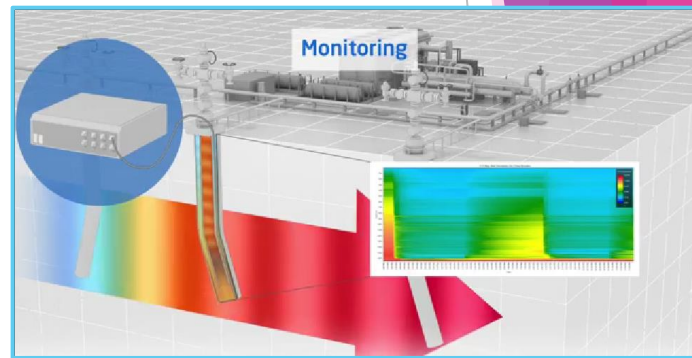
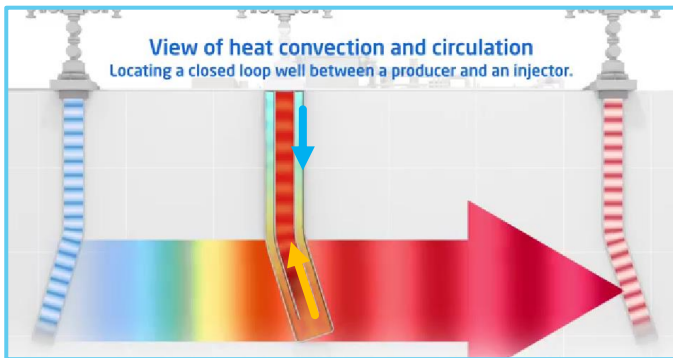

### Actual Result and Example

- PT Inti Karya Persada Teknik (IKPT) carries out a large number of EPC (Engineering, Procurement and Construction) projects for geothermal power generation facilities.
- TOYO has a track record of operation and maintenance support of downhole monitoring and DX-PLANT® in the oil and gas upstream field and fertilizer plants.
- TOYO and PT Geo Dipa Energi (GDE), Indonesia's state-owned geothermal development company, signed a memorandum of understanding, to conduct a joint study on comprehensive geothermal utilization, including green power generation, geothermal closed-loop technology, mineral recovery from-produced hot water, and green fuel generation.
- TOYO is discussing with multiple geothermal operators in Indonesia toward the demonstration and commercialization of "Geothermal Closed Loops".

#### Contact Us:

TOYO Engineering Corporation  
Carbon Neutral Business Division

—Tel: +81-47-454-1725

Haruhiro Suzuki - Product  
Manager

—E-mail:

[haruhiro.suzuki@toyo-eng.com](mailto:haruhiro.suzuki@toyo-eng.com)

—Web site:

<https://www.toyo-eng.com/jp/ja/>

# Products for the Renewable Energy Market (Solar and Geothermal)

- Easy construction, shortened construction lead time, and reliable quality -

## PT. Furukawa Electric Indonesia

### Product Overview

- ▶ Products for solar and geothermal power generation
- Flexible aluminum cable for LV
- Fiber Optic
- PV cable
- Weather resistant conduit
- Green Trough
- EFLEX
- Duct seal putty
- Fire Stop products, etc.

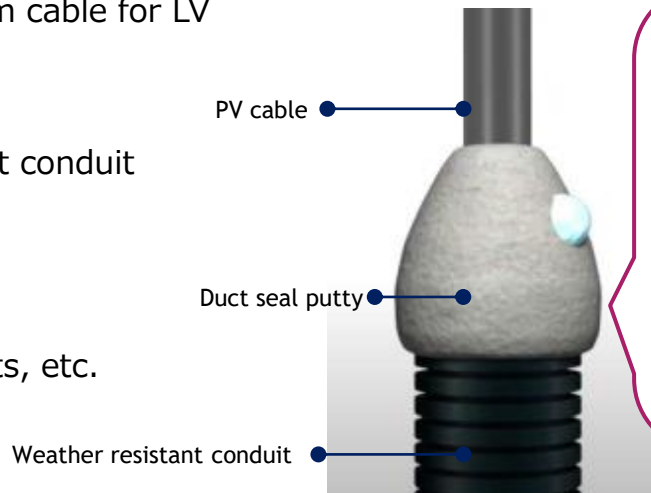

Duct seal putty

**No melting** in high temperature and high humidity

Easy installation, Light weight, half of other products.

### Feature

- PT. Furukawa Electric Indonesia deals with a wide range of cables, piping cable, fire stop products, and power storage systems, etc. for the renewable energy market.
- Products based on the concept of "safe, secure, and comfortable living".
- Ample examples of adoption in ODA projects and private renewable energy facilities.

Maximum 24 kg  
Easy to carry and safe  
Green trough  
from Recycled materials

### Recycled Cable Trough

Environmentally friendly cable troughs made from recycled materials for containers and packaging



### Contact Us:

PT. Furukawa Electric Indonesia

—Phone number: +62-21-3190-6212/ +62-811-1156123 (Japanese, English and Indonesian)

—E-mail address: [shinichi.kakimoto@furukawaelectric.com](mailto:shinichi.kakimoto@furukawaelectric.com) (Japanese and English)

[arief.budiman@furukawaelectric.com](mailto:arief.budiman@furukawaelectric.com) (Japanese, English and Indonesian)

## 2. Biomass/Waste Power Generation

- **Clean Biomethane Fuel Manufacturing Business**  
(JGC HOLDINGS CO., LTD.)
- **NF Nanotechnology (NEFS Device)** (Nanofuel Co., Ltd.)
- **Sustainable Aviation Fuel (SAF) Business**  
(JGC HOLDINGS CO., LTD.)
- **Sustainable Aviation Fuel (SAF) Production**  
(CHIYODA Corporation)
- **Energy Recovery from Factory Wastewater with Energy-Saving WWT System**  
(AIKEN KAKOKI K.K.)
- **Effective Utilization of Oil Palm Trunks Project**  
(Green Earth Institute Co., Ltd.)
- **Manufacturing and Selling Biomass Pellet Fuel Made from Palm-Derived Agricultural Residues**  
(TESS Engineering Co. Ltd./PT PTEC Research and Development)
- **Renewable Natural Gas Production and Distribution Business**  
(PT. Energasindo Heksa Karya )
- **Development/Manufacturing/Sales of Pellets Fuel Using Agriculture Residues** (Toda Corporation Co., Ltd)
- **Biomass Fuel from EFB/Fertilizer Ingredient from Chicken Manure** (Hitachi Zosen Corporation)
- **Biomethane Supply** **NEW** (PT. OSAKA GAS INDONESIA)

# Palm oil wastewater (POME) as a raw material Clean Biomethane Fuel Manufacturing Business

JGC HOLDINGS CO., LTD.

## Products and Service Outline

- ▶ The palm oil industry contribute to 4.5% of GDP and 3 million jobs in Indonesia and is regarded as a key industry in the country.
- ▶ Since the waste liquid (Palm Oil Mill Effluent : "POME) generated in the oil extraction process of palm oil contains a large amount of organic matter, it is subjected to an anaerobic fermentation treatment in an open lagoon of an open atmosphere prior to discharge into a river and an environment, but in the process, a large amount of methane is generated and released into the atmosphere (methane causes greenhouse effect of 25 times as compared with CO<sub>2</sub>)
- ▶ Emissions of GHGs from POME in Indonesia are about 36 million tons per CO<sub>2</sub>e per year, and measures against emission methane are an urgent issue.
- ▶ The four companies jointly concluded MOUs at the 2022 AGGPM Forum for the recovery of methane discharged from Indonesian palm oil waste fluids and the production of biomethane fuels.

## Actual Results and Examples

- Business: Sales of methane with bio-certification and issuance and sale of carbon credits
- Partner companies: Pertamina Gas Negara, Osaka Gas and INPEX, JGC Holdings
- Biomethane production: 10,000 tons/year\*  
Planned production increase to 0.1 million tons/year by 2030
- Reduced GHG emissions: 8,000 tons/ year (fuel conversion to biofuels)/150,000 tons/ year (methane recovery)
- Start of operations (forecast): Q1 2025



パーム油産業  
GDP: 4.5%  
雇用総数: 300万人

品名	7月
パーム油 生産量	4,350万トン/年
POME(廃 ガスの発生量)	1.37万トン/年 (=2020年実績)
POME由来 GHG排出量 (CO2換算)	3,600万トン/年

AGGPM 2022



## Contact Us:

JGC Holdings Corporation, Tomoaki Matsuo, +81-45-682-8455, [matsuo.tomoaki@jgc.com](mailto:matsuo.tomoaki@jgc.com)  
PT JGC Indonesia, Toru Wagatsuma, +62-811-1920-6686, [wagatsuma.toru@jgc.com](mailto:wagatsuma.toru@jgc.com)



# NF Nanotechnology (NEFS Device)

Achieving "Carbon Neutrality" with Non-Liquid Fossil Fuels and New Liquid Biomass Fuels

Nanofuel Co., Ltd.

## Product and Service Outline

-The NEFS system has reduced fuel costs and hazardous substances-

- ▶ Manufacture/sales/maintenance of nano-emulsion fuel equipment
- ▶ Development/manufacturing/sales of new liquid biomass fuel using nanotechnology
- ▶ Diesel power generation business using new liquid biomass fuel
- ▶ Development/manufacturing/sales/maintenance of agitator for various liquid fuel

NF company NEFS equipment



[300L · 1000L/hr]

Certified as "Low Carbon Kawasaki Brand" 2021



## Actual Result and Example

-Nano-emulsion significantly improves combustion efficiency-

1) Nano Fuel Co., Ltd.'s nanotechnology NEFS equipment reduces the consumption of liquid fossil fuels, cuts costs through energy savings, and reduces harmful emissions such as CO<sub>2</sub>, NO<sub>x</sub>, and PM.

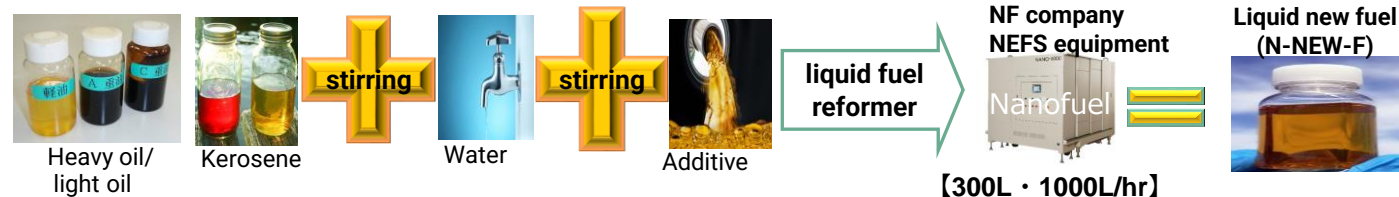

-Production process of BDF and by-product glycerin-

2) We have succeeded in developing a nanoglycerin fuel and manufacturing system that solubilizes by-product glycerin and liquid fossil fuels such as light oil using our unique nanotechnology. Demand for this fuel is expected to be high, as it is significantly cheaper than diesel fuel. In addition, CO<sub>2</sub> can be reduced, and oil imports will be reduced.

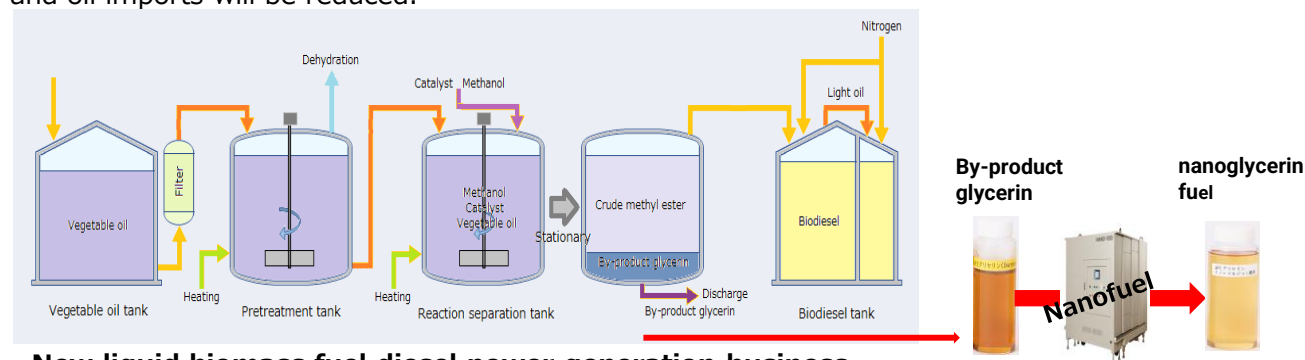

- New liquid biomass fuel diesel power generation business -

3) In Indonesia and Malaysia, we will generate diesel power using locally produced palm oil and its oxidized oil as fuel. Our technology reforms the fuel to improve combustion efficiency, and it is possible to use non-edible oils such as PAO/glycerin, reducing electricity costs.

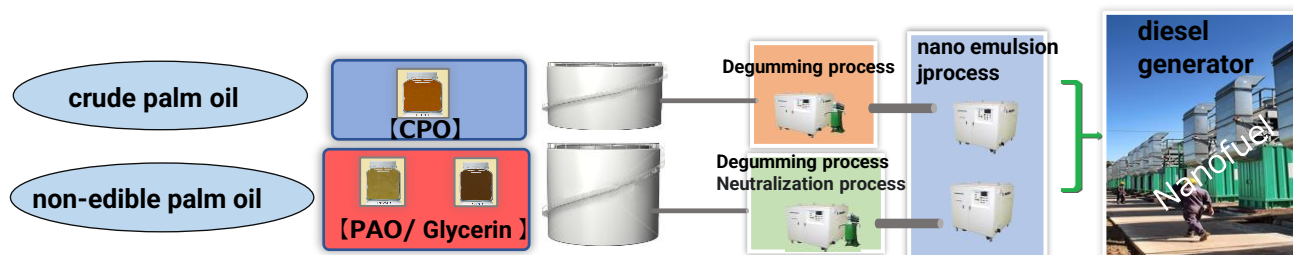

## Contact Us:

-Phone number: +81-44-270-1611 ( T.Matsumura<Mr>/M.suno<Ms>/H.Ishiyama<Mr>)

-E-mail address: [t.matsumura@nanofuel.co.jp](mailto:t.matsumura@nanofuel.co.jp), [m.suno@nanofuel.co.jp](mailto:m.suno@nanofuel.co.jp), [Ishiyama.cottonfield@gmail.com](mailto:Ishiyama.cottonfield@gmail.com)

# Sustainable Aviation Fuel (SAF) Business

JGC HOLDINGS CO., LTD.

## Products and Service Outline

- Amid efforts to reduce global CO<sub>2</sub> emissions, the airline industry also set a target (CORSIA) to prevent CO<sub>2</sub> emissions from increasing from 2020 onward in the international airline sector. Significant reductions in effect gas emissions can be expected from the introduction of SAF as a solution. SAFs can reduce CO<sub>2</sub> emissions by about 80% over conventional aviation fuels over the lifecycle from the production and collection of raw materials, such as biomass, waste food oil, and municipal waste, to manufacturing and burning. Existing infrastructure can also be used as is.
- JGC Group established a Japanese SAF manufacturing supply chain in collaboration with a partner for Japan's first large-scale commercial production of SAF. It also conducts FS and technical valuations. Based on the results and knowledge of these SAFs, furthermore, it is possible to provide highly reliable services such as support for commercializing and optimal scheme proposals.

## Actual Results and Examples

- JGC Group is working with Levo International Co., Ltd. and Cosmo Oil Co., Ltd. to create a domestically produced SAF manufacturing supply chain by hydrotreatment of Used Cooking Oil(UCO). A SAF production plant with an annual production capacity of approximately 30,000 kL is planned to be put into operation in 2025, with the Cosmo Oil Sakai Refinery as its base, using waste edible oil recovered from restaurants and food factories by Levo International Co., Ltd.
- In addition, in collaboration with Levo International, Inc., All Nippon Airways Co., Ltd., Japan Airlines Co., Ltd., and other companies, we established ACT FOR SKY, a volunteer organization working to commercialize, disseminate, and expand domestic SAFs. In the future, it aims at the development of Japan's aviation network and the industry as well as the realization of a sustainable society.



Business entity	JGC HD (60%), Cosmo Oil (30%), Levo International (10%)
FEED+EPC	JGC
Plant Construction site	Cosmo Oil Sakai Refinery
Start of operation	2025 (planned)

(Record)

Customer	Partner	Country	Scope	Raw materials	Process	Capacity	Completed
A	—	Asia	FEED	Sugar cane	ATJ	100,000 kl/yr	In progress
—	Cosmo Oil, Levo International	Japan	FEED, EPC	UCO	HEFA	25,000 kl/yr	2025 (planned)

## Contact Us:

JGC Holdings Corporation, Kenji Kawabata, +81-45-682-8333, [kawabata.kenji@jgc.com](mailto:kawabata.kenji@jgc.com)

PT JGC Indonesia Toru Wagatsuma, +62-811-1920-6686, [wagatsuma.toru@jgc.com](mailto:wagatsuma.toru@jgc.com)

# Sustainable Aviation Fuel (SAF) Production

Plant Operation Optimization by AI System

## CHIYODA Corporation

### Product and Service Outline

- ▶ The use of SAF is being promoted as a decarbonization of the aviation industry.
- ▶ Renewable energies are subject to large fluctuation ranges, and their use in plants requires technology to absorb these fluctuations and ensure stable operation.
- ▶ Our AI technology can predict the amount of electricity generated from renewable energy sources and provide dynamic, optimized operating metrics for complex downstream plant operations.

#### Units

##### Operation Control

real-time reaction control, visualization of the reaction state, and yield prediction



##### Improvement of Plant Availability

Detecting signs of operation abnormalities and failures reduces unplanned equipment outages, contributing to stable equipment operation and reduction of operating costs.



##### Trouble prevention

Providing O&M support, trouble prevention by remote monitoring / equipment diagnosis.

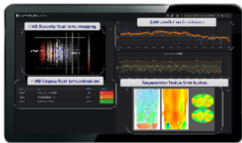

Anomaly Prediction AI system

#### Plant

##### Productivity improvement

Plant operation optimization, operation automation / autonomy by real-time operation control



##### Reduction of environmental load

Improve productivity by optimizing operation and plant efficiency reduce GHG emissions



##### Advanced maintenance

Quantitatively evaluate the damage accumulated in each device and instrument in real time provides maintenance plan

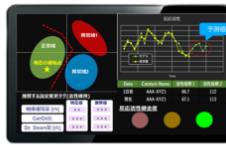

Plant AI Optimizer

#### Supply Chain

##### Data integration platform

Collecting and creating linkage for all design, plant operation, equipment management, inspection data, etc.

Mirai Fusion

##### Effective use of data and information

- Optimization of supply and demand balance
- Sophistication of operation, security and maintenance
- Production planning, Risk management
- BtB collaboration (tracking by blockchain technology)



Mirai Fusion

### Actual Results and Example

- ▶ The effects of modeling reaction and overall optimization have been confirmed in various process plants.
- ▶ Early detection of abnormalities caused by process fluctuations and automatic optimization as a set will reduce operator load, ensure safe plant operation, and optimize the cost balance.

#### Contact Us:

CHIYODA Corporation  
+81-45-225-4725

Digital Marketing Section  
[digital@chiyodacorp.com](mailto:digital@chiyodacorp.com)

# Energy Recovery from Factory Wastewater through Energy-Saving WWT System

-Water Pollution and the Utilization of Energy from Unused Prevention of Biomass Resources -

## AIKEN KAKOKI K.K.

### Product and Service Outline

#### ► Demand in Palm Oil Industry

The palm oil industry and the dyeing industry, which are Indonesia's major industries, mainly treat their factory wastewater in open treatment ponds. In addition to water pollution, the release of biogas into the atmosphere is an issue.

#### ► Proposed Product and Technology

Targeting the food and chemical industries such as palm oil factories and dyeing factories, the organic wastewater from these factories will be treated with high efficiency. Meanwhile, biogas and biofuel generated from the treatment process are recovered and used to prevent water pollution, reduce GHG emissions and contribute to the return on investment.

#### ► Expected Result

A stable treatment for industrial wastewater and prevention of the release of biogas into the atmosphere. The use of recovered energy (biogas and biofuel) as fuel for generators and boilers will promote the decarbonization of factories and create economic benefits.

### Achievements

- Approximately 20 years of development and commercialization, and more than 20 units installed.
- Other than palm oil industry, the technology is installed in the general food industry (beverages, agriculture product processing, seafood processing, dairy products, confectionery, seasonings, fermented products, etc.) and general chemical industry (dyed textiles, daily necessities, bioethanol, etc.).

### Examples

- Agricultural Product Processing Plant**  
Prior to the installation, the operation costs on water treatment were 150 million yen/year. After the installation, it generated profit 35 million yen. There is an economic effect around 200 million yen annually, resulting in the investment value recovered within ±3 years. In addition, more than 2,000 t-CO<sub>2</sub> GHG reduction has been achieved per year.
- Textile Factory**  
Prior to the installation, the operation costs were about 100 million yen/year, after the installation, the factory earn additional profit at 10 million yen, and resulting in an economic effect of more than 100 million yen/year.
- Palm Oil Industry**  
From April 2023, as a JICA project, we are planning to install the equipment at the state-owned palm oil factory (PTPN5) in Riau.

#### 【Example Cases (Japan)】

Vol.	COD	Electricity Generation	Industry
m <sup>3</sup> /d	Influent	kWh/d	
1,000	6,000	5,760	Agriculture Product
1,000	8,000	8,120	Textile
650	4,300	2,817	Food

Granular sludge



Biofuel



EGSB WWTP (2.6Φx15H)

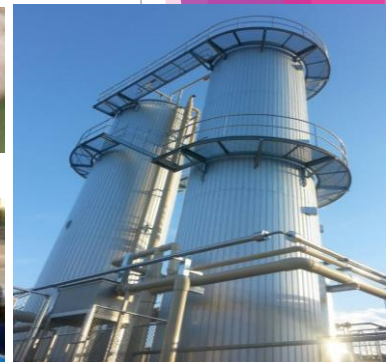

Energy recovery from WW (Net zero energy type WWTS)

《core parts》

- GSS (Gas-Solid-Separator) : Gas-solid-liquid separator
- Granules: Anaerobic Microbes (Methanogens)

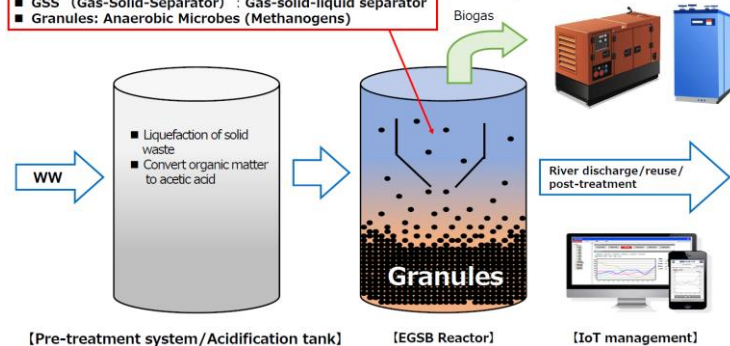

### Contact Point

#### Aiken Indonesia Representative

- Mr. Syaikhul Muqorrobin (English and Bahasa Indonesia support) : Phone number : +62-878-7734-8486
- Yoshihiro Iwata (Japanese · English) : [y.iwata@aiken-h2o.com](mailto:y.iwata@aiken-h2o.com)



# Effective Utilization of Oil Palm Trunks Project

Building the Integrated Business of Biofuel and Green Chemical utilizing Oil Palm Trunk

## Green Earth Institute Co., Ltd.

### Business Outline

- ▶ Palm oil is the most widely used vegetable oil in the world for food, detergents, and cosmetics. The demand and production of palm oil is also increasing year by year. Oil palm trees in plantations that support such enormous global demands are regularly replanted to maintain the yield of palm fruits, and a large amount of OPTs are discarded every year. Until recently, OPT has been shredded and landfilled in plantations, but in recent years, its utilization as a source of biofuel has been attracting attention.
- ▶ Our business is an initiative to integrate the production of OPT pellets and the fermentation and production of bioethanol and other chemicals from the OPT squeezed juice generated during the production of OPT pellets.
- ▶ These new business initiatives are expected to contribute to the healthy development of the palm oil industry as an effective way to utilize OPTs that have been disposed in the past and upcycle them into biofuels and chemicals.
- ▶ The reduction of CO<sub>2</sub> emissions in the aviation sector is a challenge shared by the world. The main means of achieving this goal is the introduction of SAF (Sustainable Aviation Fuel). We are planning to conduct a feasibility evaluation of a project to produce bioethanol, the raw material for SAF, from OPT obtained in Indonesia.

### Activity Status

- Currently executing FS to building up integrated OPT business in Indonesia with a business company.

### Bioconversion Technology by Green Earth Institute

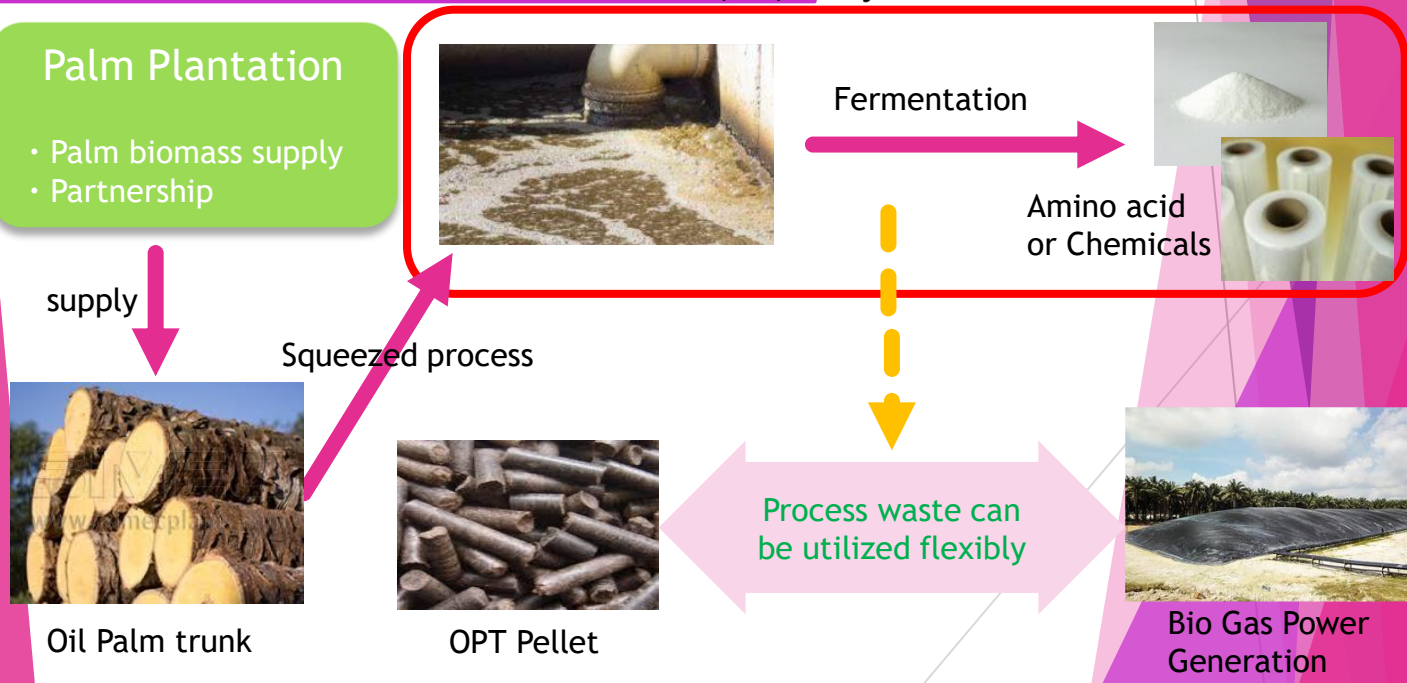

### Contact Point

Green Earth Institute Co.,Ltd.,  
Green Earth Institute Co.,Ltd.,

Jumpei Kato, +81-90-5211-8920 , [jkato@gei.co.jp](mailto:jkato@gei.co.jp)

Takakiyo Ichino, +81- 80-7499-7271 , [ichino@gei.co.jp](mailto:ichino@gei.co.jp)

# Manufacturing and Selling Biomass Pellet Fuel Made from Palm-Derived Agricultural Residues

TESS Engineering Co. Ltd.  
PT PTEC Research and Development



## Overview of Products and Services 【BACKGROUND】

- ▶ Palm-derived residues (EFB & OPT) are currently **left unused** and **contribute to the generation of methane gas (25 times more potent than CO<sub>2</sub>)**. Reducing the impact of palm-derived residue is an urgent matter.
- ▶ To achieve the goal of a "decarbonized society" set by the Japanese and Indonesian governments, it is crucial for manufacturers to make **transition from fossil fuels to decarbonized alternatives fuel**.

## 【Business Description】

- ▶ We **manufacture pellet fuel from unused residues (EFB & OPT)** and sell it to thermal power plants in Indonesia and overseas. Switching from fossil fuels to our biomass pellet is **expected to reduce CO<sub>2</sub> effects that is equivalent to 240,000 t-CO<sub>2</sub> per year (\*\*)**.  
\*\*including the methane suppression effect resulting from utilizing abandoned EFB

## Achievements/Examples

- ✓ **Test plant** in operation since 2021
- ✓ Construction plan for **commercial plant**.  
Production volume: 200,000t/year  
Operation commence: year 2025
- ✓ Already conducted **co-firing combustion tests at several coal-fired power plants** in Japan and Indonesia
- ✓ Already conducted **several combustion tests for drying furnace** in Indonesia
- ✓ Established **partnership with PTPN (state owned palm company)** regarding supply of raw materials and land

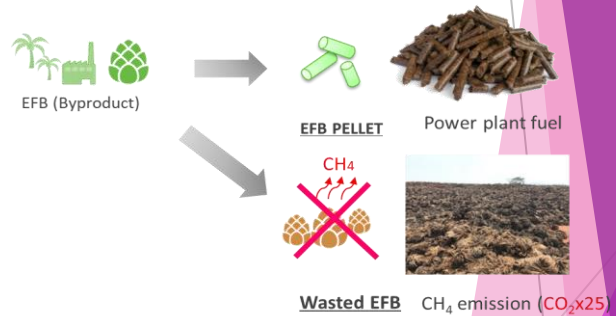
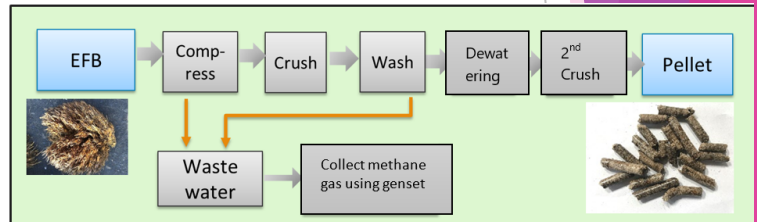

## Contact Information

PT PTEC Research and Development

Mr. Iwaki +62-(0)811-9760-108 [sho.Iwaki@tess-eng.co.jp](mailto:sho.Iwaki@tess-eng.co.jp) (Available Japanese, English & Indonesian)

Mr Suwaki +62-(0)811-700-9807 [yasufumi.suwaki@ptec-rd.com](mailto:yasufumi.suwaki@ptec-rd.com) (Available Japanese & English)

# Renewable Natural Gas Production and Distribution Business

## Decarbonization of thermal energy

### PT. Energasindo Heksa Karya (invested 33% by Tokyo Gas)

#### Business outline

- ▶ PT. Energasindo Heksa Karya (hereinafter referred to as EHK) is a company engaged in the transportation and distribution business of natural gas, and has experience to convert from other fossil fuels to natural gas which is a stable energy and low carbon fuel.
- ▶ This project will recover methane (CH<sub>4</sub>) generated from raw material supply partners' organic waste and agricultural and livestock composts/residues to produce a gaseous decarbonized fuel (RNG) that can be used in the same way as natural gas. Also, this is a business that supplies RNG to nearby partner factories.

#### Expected effects

- ▶ Raw material supply partners : It can contribute to reduce and effectively utilize greenhouse gases generated from factory wastewater, organic waste, and various composts/residues.
- ▶ Gas use partners: Enables decarbonization of energy, clean exhaust gases, and the use of highly efficient and easy-to-maintain gas-fueled equipment.

EHK leverages our know-how of natural gas distribution business to connect Raw material supply partners and Gas use partners to decarbonize and provide a stable energy.

#### Actual result and example

- Operation area of natural gas business :  
Java Island (West Java, Banten, Central Java) ,  
Sumatra Island (Jambi, Riau)
- Raw material supply partners :  
Palm plantation, Livestock farm, Others
- Gas use partner :  
PT. Moriuchi Indonesia(MI), Others
- Under studying business feasibility of RNG production and supply for MI in Bandung, West Java.

Location	West Java
RNG size	100mmbtu/day
Target	2025~

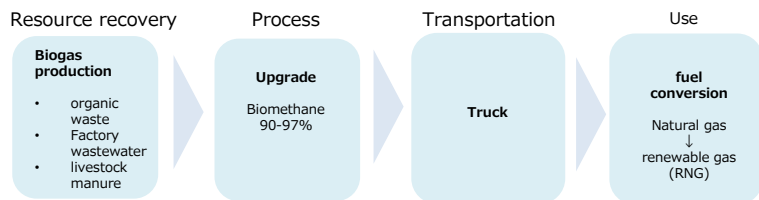

Signed a memorandum of understanding regarding RNG joint development with PT.Moriuchi Indonesia (Gas use partner)

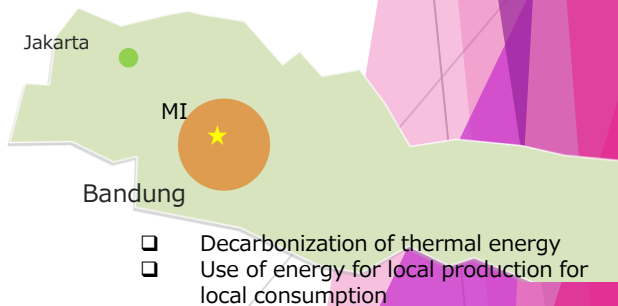

#### Contact point

##### PT. Energasindo Heksa Karya

Nagaki (Mr.) : +62-815-1175-1204, [kengo.nagaki@energasindo.com](mailto:kengo.nagaki@energasindo.com) (Japanese/English)

Yamaguchi (Mr.) : +62-811-1910-0564, [yutaro.yamaguchi@energasindo.com](mailto:yutaro.yamaguchi@energasindo.com) (Japanese/English)

Ramadytio (Mr.) : +62-21-23579930, [ramadytio.fadhli@energasindo.com](mailto:ramadytio.fadhli@energasindo.com) (Bahasa Indonesia/English)

# Development/Manufacturing/Sales of Pellets Fuel Using Agriculture Residues Zero Emissions & Value Added



Toda Corporation Co., Ltd (PT Toda Group Indonesia)

## Business Summary

- ▶ 2021, We've started considering the treatment of agriculture residues generated by our local partner's plantation group.
- ▶ 2022, Among agricultural residues, we focused on EFB, as our partner not utilized it & study on conversion method started to turn it into fuel.
- ▶ 2023, Started manufacturing & selling wood pellets using wood waste generated from producing pulp.

### Problem of Wood Waste



- Incineration process generates CO<sub>2</sub>
- Costly due to high fuel prices



### Problem of EFB



- High moisture content
- High **potassium** and **chlorine** content  
→ **Clinker** generate Boiler clogging



- **Unsuitable for fuel**
- **Methane gas** generation during composting process



Global warming potential is equivalent to 25 times of CO<sub>2</sub>

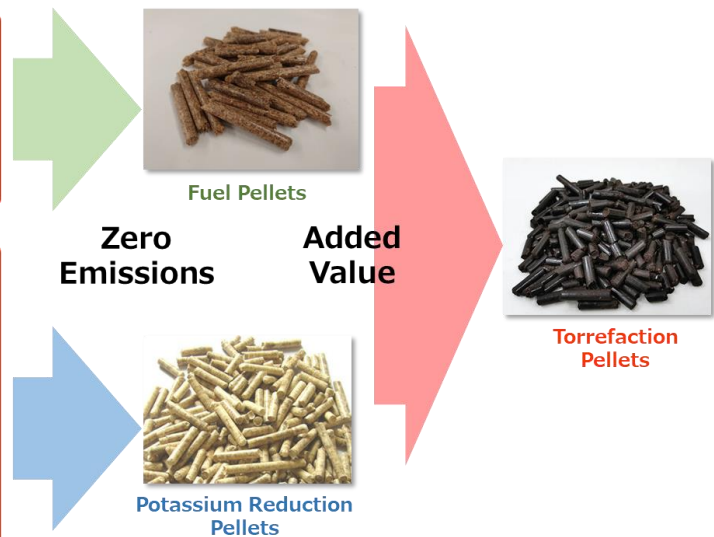

**Countermeasure for global warming through appropriate treatment and effective utilization**

- We're obtaining FSC certification for wood pellets (to be issued in 2023).
- In the future, we plan to expand export sales of WP (mainly to Japan).
- In parallel, we will continue developing the several agriculture residues (mainly EFB) to achieve zero emissions & adding value to this waste.

## Contact us

Toda Corporation Co., Ltd  
PT Toda Group Indonesia

: [ryuu.kuge@toda.co.jp](mailto:ryuu.kuge@toda.co.jp) (Mr. Kuge)

: [priatna.suheri@todagroup.co.id](mailto:priatna.suheri@todagroup.co.id) (Mr. Heri)



# Biomass Fuel from EFB/ Fertilizer Ingredient from Chicken Manure

Hitachi Zosen Corporation

## Product and service outline

- ▶ EFCaR (Energy Free Carbonizing for Resource Recovery) is our technology to convert organic waste into carbide. In Indonesian market, the following organic wastes are targeted.
  1. **EFB(Empty Fruits Bunch)**: Carbide from EFB can be utilized **for biomass fuel**.
  2. **Chicken Manure**: Carbide from chicken manure can be utilized **for fertilizer ingredient**.
- ▶ Outline of System:  
Throughput: Organic waste like EFB, chicken manure (Water Content 65%): 31tpd  
**Throughput: Organic waste like chicken manure (Water Content 40%): 18tpd x 1 unit**  
Carbide Production Ratio: 30% (5.4tpd)  
**CO<sub>2</sub> Reduction: approx. 1,000tpd** (depending on project conditions)
- ▶ Eligible for **JCM** (Joint Crediting Mechanism), a Japanese government financial support.
- ▶ We are pleased to be in contact with the companies below.
  1. Agricultural companies own palm mills and/or chicken farms as a supplier for organic waste
  2. Companies for cement, steel industry, etc. as an off-taker

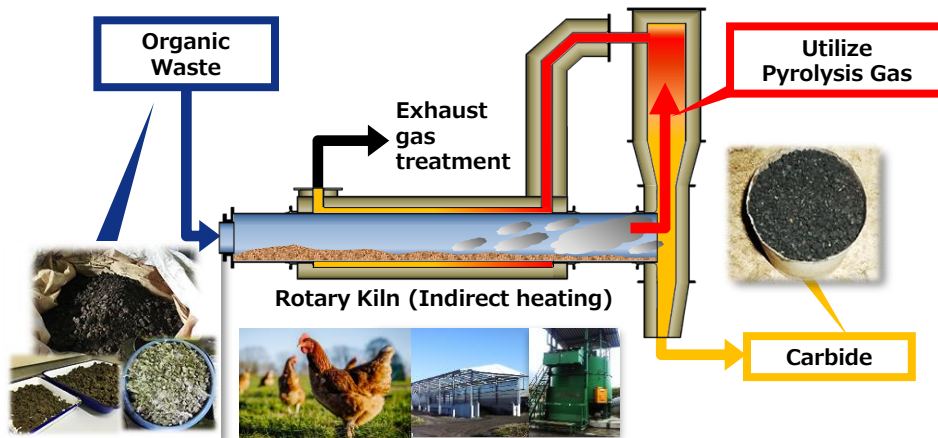

1. Continuously producing carbides **under uniform temperature without fossil fuel**.
2. Carbide constituents for fertilizer have high solubility so that **they can be absorbed well**.
3. In the process, harmful substances like pesticides, antibiotics etc. **are decomposed and detoxified**.
4. **No unpleasant smell of livestock** remains once it is converted into carbide.

## Actual result and example

- Operational demonstration has been successfully conducted. Commercialization in FY2024 is aimed.

## Contact point

Hitachi Zosen Corporation, Yasukazu Aono

WA&TEL: +62-811-1020-237, Email: [aono@hitachizosen.co.jp](mailto:aono@hitachizosen.co.jp)

# Biomethane Supply

Reduction of greenhouse gas (Scope 1) emissions with no initial investment

PT. OSAKA GAS INDONESIA

## Overview of services

- ▶ The company provides biomethane supply by pipeline. We can offer your support regarding to natural gas and biomethane supply.
- ▶ Biomethane will be produced in Sumatra by 4 companies namely, Osaka Gas, JGC Holding, INPEX and PGN, and supplied through existing pipelines to customers in Java area.

## Characteristics of biomethane.

- No initial investment because the existing facilities can be utilized
- Reduction of Scope 1 greenhouse gas emissions with ISCC Plus certification, an international certification scheme.
- The ratio of biomethane can be selected.

## Biomethane supply overview (Plan)

- Start of supply in 2025
- Biomethane volume 440,000 MMBTU/year
  - ※Volume is planned to increase 10 times by 2030.
- Greenhouse gas reductions (Scope 1) 0.058 t-CO<sub>2</sub>/MMBTU
  - ※In case of conversion from Natural gas to Biomethane
- Biomethane supply period More than 10 years
- Biomass certification scheme ISCC Plus.

## Other services

- Support of making a carbon neutral strategy
- Support for fuel switching from coal and oil fuels to natural gas
- Energy conservation consulting services

## contact point

PT. OSAKA GAS INDONESIA

Summitmas I, lantai 9 Jl. Jend. Sudirman Kav 61-62.

Jakarta-12190, Indonesia

Name :Yoshihiro Izutani

Telephone number : +62-21-2522572

E-mail address : y-izutani@osakagas.co.jp

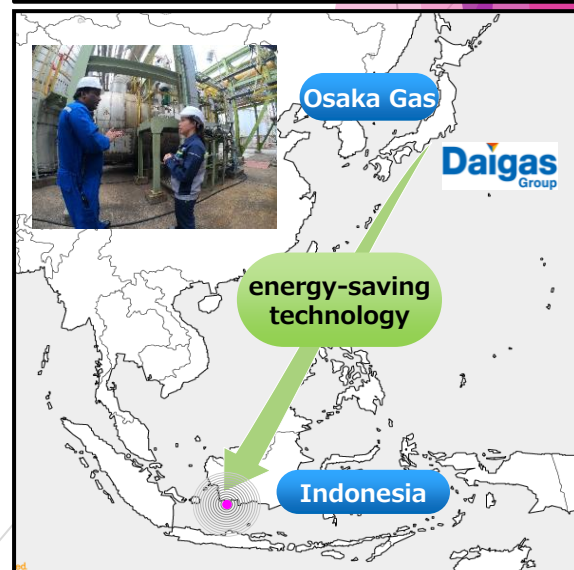
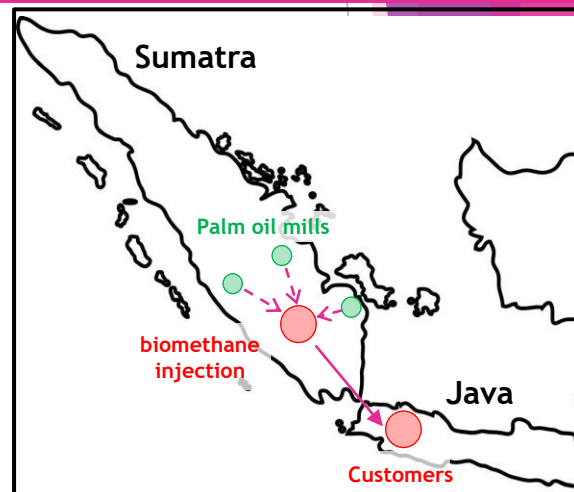

### 3. Decarbonization of Fossil Fuels, CCUS/Carbon recycling

- **CCS Technologies Supporting the Transition to a Decarbonization** (JGC HOLDINGS CO., LTD.)
- **Carbon Recycling Technology** (CHIYODA Corporation)
- **CT-CO2AR™ CO<sub>2</sub> Reforming Catalyst** (CHIYODA Corporation)
- **CO<sub>2</sub> Reduction with Gas Co-Generation** (PT. MHI ENGINE SYSTEM INDONESIA)
- **CO<sub>2</sub> capture technology to support de/low-carbonization in a wide range of industrial fields** (PT. Toshiba Asia Pacific Indonesia)
- **Hydrogen/Ammonia Regenerative Burner/Air Pollution Control System** **NEW** (PT. CHUGAI RO INDONESIA)

# CCS Technologies

## Supporting the Transition to a Decarbonization

JGC HOLDINGS CO., LTD.

### Outline of Services

▶ CCS stands for Carbon dioxide Capture and Storage and refers to the collection and storage of CO<sub>2</sub>. This technology recovers CO<sub>2</sub> generated in the process of refining fossil fuels or by burning them into the atmosphere, injects them into the ground, and stores them stably over a long period of time. By applying these applications to CO<sub>2</sub> generated during the manufacturing and use of fossil fuels, we can reduce the environmental burden. In recent years, high attention has been paid to it as a trunk card for measures to combat global warming.

### Results and Examples

#### High-Pressure Recycled CO<sub>2</sub> Collection Process "HiPACT®"

HiPACT® has superior high-temperature durability and can separate and recover CO<sub>2</sub> at higher pressures than before, reducing the energy and equipment costs of CCUS's CO<sub>2</sub> compressors. Higher CO<sub>2</sub> absorbency also reduces the volume of amide circulation and reduces the cost of the device itself. We have a result track record of commercial equipment in natural gas plants.

### Results and Examples

#### CO<sub>2</sub> Separation Techniques Using DDR Zeolite Membranes

The DDR-type zeolite membrane is one of the largest ceramics CO<sub>2</sub> separators in the world. It allows for precise separation of CO<sub>2</sub> even under harsher conditions with higher pressure and higher CO<sub>2</sub> concentrations than in the past. We are currently conducting demonstration tests to separate CO<sub>2</sub> from associated gases in the U.S. oil field. This technology received the GSC Award Incentive Award in recognition of its past result achievements

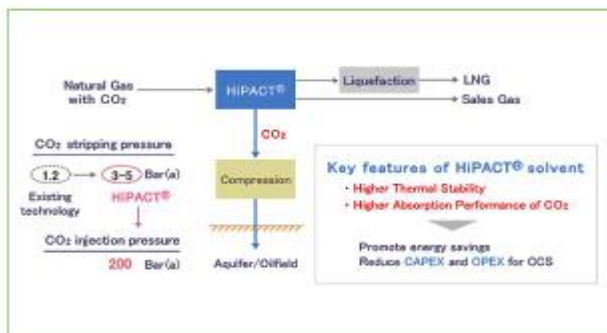

HiPACT®プラント (アラブドバイ・インドネシア・サウジアラビア・セルビア)  
HiPACT®プラント MS ad. Novi Sad (Serbia)

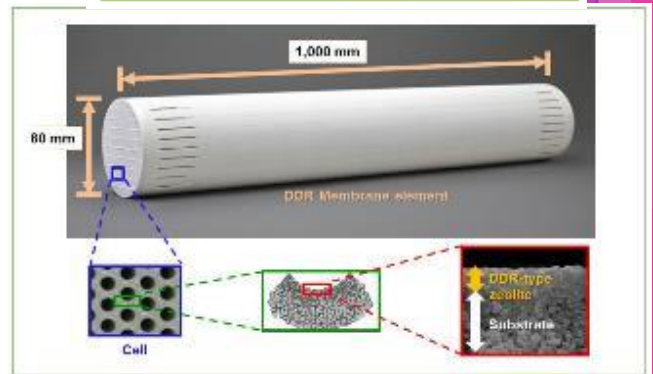
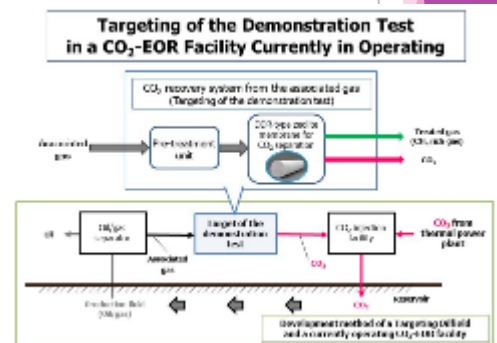

DDR 膜パイプライン

### Contact Us:

JGC Holdings Corporation, Takuya Murakami, +81-45-682-8455, [murakami.takuya@jgc.com](mailto:murakami.takuya@jgc.com)  
PT JGC Indonesia, Toru Wagatsuma, +62-811-1920-6686, [wagatsuma.toru@jgc.com](mailto:wagatsuma.toru@jgc.com)



# Carbon Recycling Technology

Solutions to Achieve Carbon Neutrality

## Chiyoda Corporation (PT. Chiyoda International Indonesia)

- ▶ Chiyoda Corporation has a wealth of experience and technology in the fields of design, procurement and construction of petroleum, natural gas and chemical plants. As a comprehensive engineering company, Chiyoda provides a variety of solutions for the realization of a decarbonized society.
- ▶ In Indonesia, we are currently conducting a feasibility study for a CCS project together with Pertamina. We are also actively working on the development of CCUS (CO<sub>2</sub> Capture, Utilization and Storage: carbon dioxide separation, recovery, utilization and storage) technologies, and are proceeding with demonstration and commercialization of those in Japan and overseas.

### Use cases

#### CCS Feasibility Study

- Conduct a Feasibility Study on the large-scale CO<sub>2</sub> capture, transportation, and storage in South Sumatra together with Pertamina and ITB.

<Scheme>

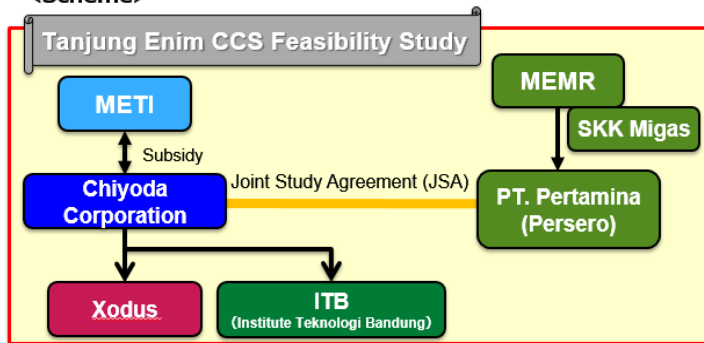

#### Para-xylene (Polyester clothes/Plastic bottles)

- Para-xylene production from CO<sub>2</sub> and H<sub>2</sub>
- Para-xylene is essential to manufacture polyester clothes and pet bottles
- R&D stage in NEDO Project (July 2020 – March 2024)
- Partnership with the University of Toyama, Nippon Steel Engineering Co.,Ltd., Nippon Steel Corporation, HighChem Company Ltd., and Mitsubishi Corporation

[https://www.chiyodacorp.com/media/200714\\_e.pdf](https://www.chiyodacorp.com/media/200714_e.pdf)

#### Carbonate (Concrete)



Waste concrete



Capture/Fix CO<sub>2</sub> with Calcium



Recycled aggregate



Aggregate

- ◆ Technology by "Blue Planet" (start-up company in US).
- ◆ Chiyoda has entered into MOU with Blue Planet and Mitsubishi Corporation.
- ◆ Chiyoda participates in project demonstration in US by providing technical support and accelerating commercialization.

[https://www.chiyodacorp.com/media/210205\\_e.pdf](https://www.chiyodacorp.com/media/210205_e.pdf)

### Contact Us:

PT. Chiyoda International Indonesia

Tel: +62 21 2903 9255

E-mail address: [ueda.ayaka@chiyodacorp.com](mailto:ueda.ayaka@chiyodacorp.com)

### Chiyoda Corporation (PT. Chiyoda International Indonesia)

#### Product and Service Outline

- ▶ CT-CO2AR™ is a unique & advanced technology utilizing CO<sub>2</sub> as reforming agent to efficiently produce synthetic gases of varying H<sub>2</sub>/CO ratios.
- ▶ CT-CO2AR™ enables the monetization of low-calorie, CO<sub>2</sub>-containing natural gas fields and can also be applied to the efficient reuse of CO<sub>2</sub> emitted from various industrial processes.
- ▶ Synthesis gases are the feeds for producing various chemicals and liquid fuels (DME, GTL-fuels etc.).
- ▶ The CT-CO2AR™ consumes CO<sub>2</sub> as a reforming agent and in tandem with its unique reforming catalyst, achieves high energy-efficiency. CT-CO2AR™ is thus, an environment-friendly technology due to significant reduction in emissions.

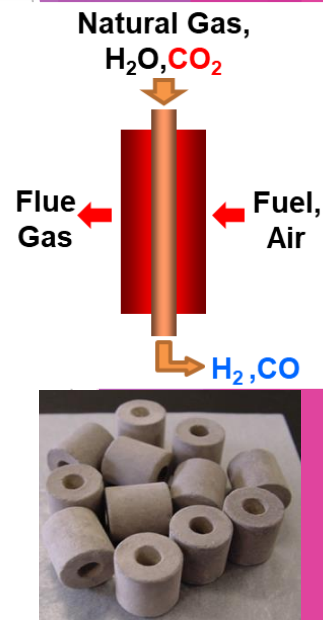

See more on youtube: [https://www.youtube.com/watch?v=f6TtF\\_vm-E](https://www.youtube.com/watch?v=f6TtF_vm-E)

#### Feature

- **Direct production of Synthesis gases with a wide range of H<sub>2</sub>/CO ratios**  
CT-CO2AR™ enables the efficient production of synthesis gases with a wide range of H<sub>2</sub>/CO ratios by varying the feed gas ratios such as steam/carbon ratio and CO<sub>2</sub>/carbon ratio.

#### CT-CO<sub>2</sub>AR™ (Chiyoda CO<sub>2</sub> Reforming Catalyst)

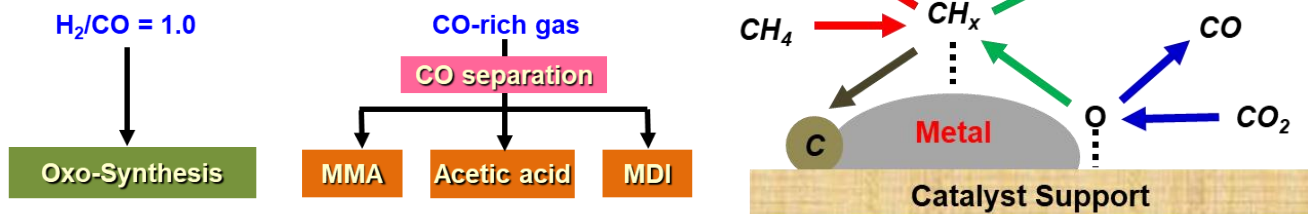

- **Synthesis gas production under optimum conditions with a novel catalyst**  
CT-CO2AR™ has high resistance to carbon formation, and results in significant reductions in the amount of steam and CO<sub>2</sub>. Consequently, CT-CO2AR™ produces synthesis gases with high energy efficiency.
- **High energy-efficiency and cost-competitive performance**  
Compared to conventional reforming catalysts, CT-CO2AR™ reduces the amount of feed, natural gas fuel and recycled CO<sub>2</sub>. This results in improved energy efficiency and a significant reduction in CAPEX, OPEX and CO<sub>2</sub> emissions.
- In the case of H<sub>2</sub>/CO=1.0, more than 10% of the total energy input (feed and fuel natural gas + utility consumption), and more than 20% of the CO<sub>2</sub> emissions are reduced compared to conventional catalysts.

#### Contact Us:

PT. Chiyoda International Indonesia

Tel: +62 21 2903 9255

E-mail address: [ueda.ayaka@chiyodacorp.com](mailto:ueda.ayaka@chiyodacorp.com)

# CO<sub>2</sub> Reduction with Gas Co-Generation

Also Contributing to BCP (Business Continuity Plan)

## PT. MHI ENGINE SYSTEM INDONESIA

### Product and Service Outline

- ▶ Under the circumstances where decarbonization efforts are required worldwide, all companies were being required not only setting their target, but also establishing a practical plan and its verification. Other than short term solution such as Renewable Energy Certificates (REC), we propose Gas Co-generation System as a sustainable and developmental solution to achieve low carbon operation of the companies.
- ▶ Compared with Japan and other Southeast Asian countries, Indonesian electricity supply is still dependent on low efficient and carbon intensive coal-fired power plants. Therefore, CO<sub>2</sub> reduction by the installation of Gas Co-generator System in Indonesia is significantly larger than other countries. Furthermore, there is an opportunity to utilize the Joint Crediting Mechanism (JCM) subsidy by the Ministry of Environment of Japan.
- ▶ Depending on the future development and availability of hydrogen and other carbon-free fuels, users may replace the engine or its components with continuous utilization of existing auxiliary system. Which means, emission reduction in the transition period is compatible with the preparation of zero carbon in the future.
- ▶ In the event of disaster, the Gas Co-generation System can generate electricity independent from the electricity grid. Such resilience contributes to Business Continuity Plan (BCP).

### Achievements and Example

- The highly reliable gas engines are developed and produced in Japan accompanied by its service system.
- The Gas Co-generation Systems have been widely installed in Japan such as automotive, food, pharmacy and chemical factories with a good achievement.
- Corresponding to electricity/heat demand and operation mode of each factory, we can propose optimal output and number of units for each factory.
- For more than 30 years of operation in Indonesia, we have supplied more than 3,000 units of engines which is reliable and can be trusted.
- In addition to supply the equipment, we also provide services related to leasing and energy for business operators.
- It is also possible to propose a method of assuming that biogas is used while using pipeline natural gas.

	MGS500G-1	MGS1000G-1	MGS1500G-1
Engine Model	GS6R2	GS16R2	
Output	500kW	1000kW	1500kW
Gen. Eff.	40.2%	44.0%	41.3%
Hot water	19.6%	13.5%	18.9%
Exhaust heat	21.3%	19.6%	22.3%
Total. Eff.	81.1%	77.1%	82.5%
Maximum annual CO <sub>2</sub> reduction amount in Indonesia	1500 t/unit	3200 t/unit	4700 t/unit

### Power Grid CO<sub>2</sub> Emissions by country

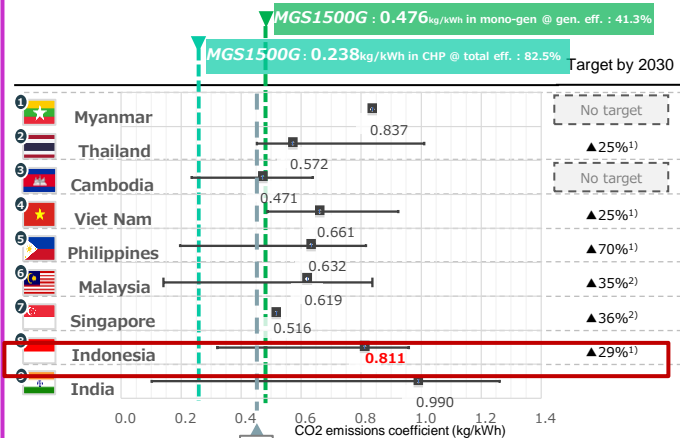

1. Compared with BAU (no additional effort made to reduce emissions); 2. Compared with 2005 (real GDP)  
 Source: <https://www.iges.or.jp/>, IGES\_GRID\_EF\_v11.0\_20221012.xlsx



### Contact Us:

PT. MHI Engine System Indonesia (Mr. Joko Nugroho and Mr. M.Muaz Afra Y English and Bahasa support)

—Phone number : +62-21-789-0191

—E-mail address : [joko.nugroho.sr@mhi.com](mailto:joko.nugroho.sr@mhi.com) & [muaz.afra.8y@mhi.com](mailto:muaz.afra.8y@mhi.com)





## PT. CHUGAI RO INDONESIA

### Product and service outline

CHUGAI RO INDONESIA was established in 2012 as a local subsidiary of Chugai Ro Co., Ltd.

We sell and provide after-sales service for Industrial furnaces, Combustion equipment, and Industrial machinery. To actualize carbon neutral, we develop combustion technology which is not emitting CO<sub>2</sub>, and heat treatment equipment for EVs, rechargeable battery, and semi-conductor component.

We will provide all solution needed by customers related to thermal technology as an effort to create sustainable society.

- ▶ Burner and combustion control equipment (hydrogen burner, ammonia burner, regenerative burner, oxygen burner, etc.)
- ▶ Plant for steel/non-steel metals and reheating furnace/heat treatment furnace (SUS-APL/BAL, Cu-APL/BAL. AL-CAL, CGL, H2-BAF, CCL/AL-CCL)
- ▶ Heat treatment furnace for automobiles mechanical parts, batteries, circuit boards, catalysts, magnetic materials, shapes of materials, pipe materials, and wire rod.
- ▶ Air Pollution Control System (RTO), Environmental Equipment (Multi-retort Rotary Kiln, Fluidized Bed Type Heating System)

BROCHURE LIST



### Actual result and example

- 1994 Developed and started sales of RTO (No. 1 system in Japan, with over 320 units ordered and delivered)
- 2018 Developed hydrogen burner in the world's first in conjunction with Toyota Motor Corporation
- 2021 Adopted for NEDO "Energy and Environment New Technology Leading Research Program (Decarbonized Industrial Furnace Using Innovative Ammonia Combustion)" and "Ammonia Mixed Firing Thermal Power Generation Technology and Verification Project"
- 2022 Order for Japan's first hydrogen combustion Exhaust gas treatment equipment
- 2023 Participated in the Ministry of the Environment's JCM Project "Decarbonization and Smart City Formation Promotion Project for Sakai city and Vietnam cities"
- 2023 Adopted for NEDO "Green Innovation Fund Project/Decarbonization of Thermal Processes in Manufacturing Field"

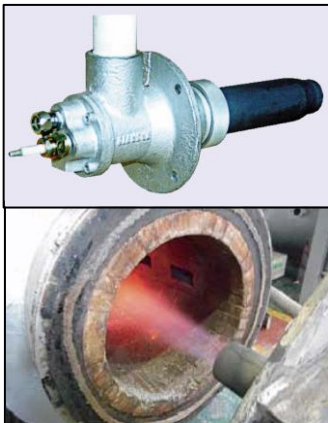

Hydrogen Burner

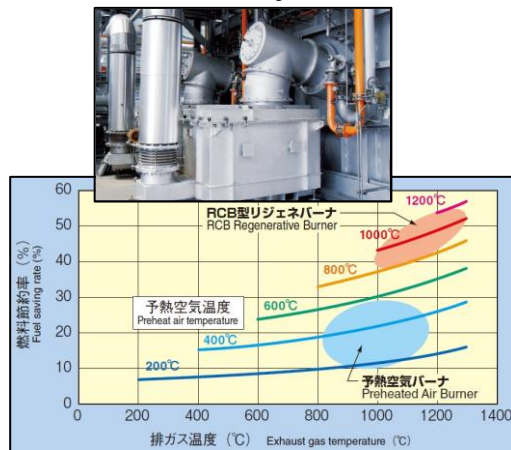

Regenerative Burner

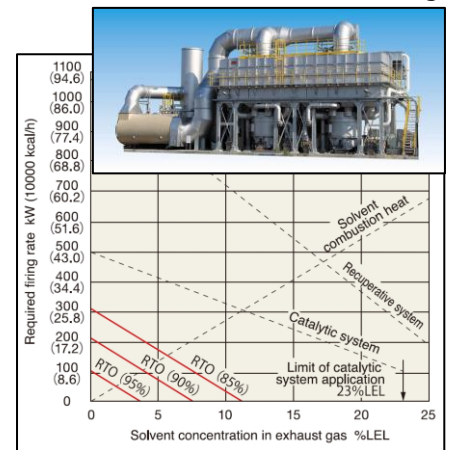

Regenerative Thermal Oxidizer(RTO)

### Contact point

PT. CHUGAI RO INDONESIA

Phone number : +62-21-5279652

Japanese/English : Tanaka Toshiaki (E-mail : [toshiaki\\_tanaka@n.chugai.co.jp](mailto:toshiaki_tanaka@n.chugai.co.jp))

Bahasa Indonesia/English : Zulfikar (E-mail : [engineeringengineering01@n-crid.com](mailto:engineeringengineering01@n-crid.com))



<https://chugai.co.jp>

## 4. Electrification of Vehicles, Battery

- **BaaS** (PT. Santomo Resources Indonesia)
- **DENDO DRIVE HOUSE**  
(PT. Mitsubishi Motors Krama Yudha Sales Indonesia)
- **Ultra Rapid Charging EV Bus** **NEW**  
(Toshiba Corporation (Battery Business Dept.))

## PT. Santomo Green Power Management

### Product and Service Outline

- ▶ While working on electric motorbike batteries using BaaS (Battery as a Service) business, we are also contributing to the realization of Indonesia's decarbonization and ecosystem construction. At the present time we are conducting electrical motorbike sale and battery replacement station service for the motorbike, and also offering services related to all of these.
- ▶ Electric motorbike being sold at present has 60 km maximum travel distance with 1.500 W power. Roughly it has the same running performance as an 80cc engine displacement gasoline motorbike. The most special feature is the battery can be switched, so it doesn't necessary to charge it at home or charge it at the charging station. The battery usually needs a charging time of around 4 to 6 hours, but this service offers a battery switch within seconds, which is realizing waiting time solution for the user's charging challenges. Users will use an exclusive application, so they can see the motorbike's condition and the nearest battery switch station.
- ▶ At the present, electric power for the battery switch station has been supplied by PLN, but by using a renewable energy source's supply which has been considered to have more contribution to carbon neutral. And for now, the battery is only used for electric motorbikes, but function expansion to use it for other household appliances has been considered and hereafter there is a plan to carry out a verification experiment.

### Actual Result and Example

- On February 17<sup>th</sup> 2022, there was an MOU signing with PT Swap Energi Indonesia, acquiring exclusive operating rights for battery swap stations in the eastern Indonesia area. At the present we established and operating 7 battery swapping stations in Makassar city, Sulawesi island. Based on the cooperation with PLN, 6 stations were established in the PLN offices within Makassar city.
- On March 18<sup>th</sup> 2022, there was an MOU signing with PT Goto Gojek Tokopedia and started free trial of 20 electric bikes to Gojek driver
- On August 29<sup>th</sup> 2022, we began installing battery exchange stations at Alfamart stores, a major convenience store chain, improving drivers' access to charging stations.
- On November 28<sup>th</sup> 2022, there was an MOU signing with PT Smoot Motor Indonesia. We have acquired exclusive sales rights for Smoot brand electric motorcycles in East Indonesia and have begun full-scale sales in the region.
- Opened a directly managed showroom in Makassar City on April 27<sup>th</sup> 2023, establishing a system to provide one-stop sales/service/spare-parts.
- On June 21<sup>th</sup> 2023, we began installing battery swapping stations at Circle K stores, a major convenience store chain. At this point, approximately 50 stations are in operation.
- On September 15<sup>th</sup> 2023, we launched a paid rental business for online drivers, including Gojek drivers.
- On December 12<sup>th</sup> 2023, we started the operation of a battery swapping station and the sale of electric motorcycles in Lombok Island.



### Contact Us:

- Phone number : +62 (0)21 50217214
- E-mail address : [shuntaro.yamaguchi@san-tomo.com](mailto:shuntaro.yamaguchi@san-tomo.com) (Japanese support)  
[sunsun.linus@gpm-swap.id](mailto:sunsun.linus@gpm-swap.id) (Indonesian Language)

# DENDO DRIVE HOUSE (DDH)

PT. Mitsubishi Motors Krama Yudha Sales Indonesia (MMKSI)

## Product and Service Outline

- ▶ DDH is an eco-system package for home use, consisting of Mitsubishi Motors' electrified vehicle, V2H(\*1) bi-directional charger, solar panels, etc. It enables the user to charge their electrified vehicle with solar generated power and conversely supply power from electrified vehicle to their home, saving electricity costs and providing convenience as an emergency power source.
- ▶ The user can save electricity costs by charging the electrified vehicle with the excess power generated by the solar panels and supplying power from the electrified vehicle to their home at night.
- ▶ By using the clean electric power generated by the solar panels to power home appliances or electrified vehicle, the user can contribute to the realization of a low carbon society.
- ▶ Even during urgent situation such as power failure, DDH provides a power source that can supply power generated by the solar panels or power from the electrified vehicle to run appliances in the home.



(\*1) Vehicle to Home: A system of supplying homes with electric power stored in electrified vehicle batteries.



## Actual Result and Example

- After being exhibited for the first time at Geneva International Motor Show 2019, DDH has been exhibited in various exhibitions such as Tokyo Motor Show.
- In March 2022, DDH was set up and opened for the public at the head office of Mitsubishi Motors Krama Yudha Sales Indonesia (MMKSI), Mitsubishi Motors' sales company in Indonesia.
- Indonesia is the third country after Japan and Thailand where Mitsubishi Motors has set up DDH in its head office-related facility.
- MMKSI's DDH has a co-working space and meeting rooms that can be used by visitors and employees, as well as an energy flow panel that visualizes DDH's flow of electricity and the amount of CO<sub>2</sub> and electricity bill reductions. It is also equipped with a power failure demonstration function, showing how the electric power is supplied from the electrified vehicle in the event of a power failure.
- Starting with the installation at the head office, MMKSI plans to continue to expand the showcase of DDH in Indonesia.

## Contact Us:

[akiyoshi.fujimori@mitsubishi-motors.co.id](mailto:akiyoshi.fujimori@mitsubishi-motors.co.id) (MMKSI: Mr. Fujimori)  
[guntur.harling@mitsubishi-motors.co.id](mailto:guntur.harling@mitsubishi-motors.co.id) (MMKSI: Mr. Guntur)



# Ultra Rapid Charging EV Bus

EV Bus system that can be realized only with SCiB™'s safety, long life, and rapid charging

## Toshiba Corporation (Battery Business Dept.)

### Product/Service Outline

- ▶ SCiB™ is a unique lithium-ion battery provides **a rapid charging of over 80% in 6 minutes, a Long life of over 20,000 charge/discharge cycles, and a high level of safety that does not burn when nailed.**
- ▶ By using SCiB™, the total number of EV buses can be reduced.
- ▶ Normally, EV buses take more than 3 hours to charge. This standby time does not exist for diesel buses. When replacing diesel buses with EV buses, spare EV buses must be **introduced** to account for this standby time. **The EV bus with SCiB™ can provide a solution to this problem.**



### Actual Result and Example

#### Reduction in the number of buses

Unlike diesel buses, EV buses require **more than 3 hours** of standby time for charging. To compensate for this standby time, you need to introduce spare EV buses. This problem will **become more apparent when all one route is replaced with EV buses**, so it will become more pronounced as EV buses become more popular in the future. On the other hand, if **EV buses** are equipped with SCiB™, the **number of spare EV buses can be reduced** by minimizing the standby time through **ultra rapid charging**.

#### Improving electricity consumption

For electric buses, **the body weight and the electricity consumption are a trade-off**. In order to travel longer distances, they need to carry a lot of batteries. If the amount of batteries is increased, the body weight will increase and the electricity consumption will decrease. On the other hand, if ultra rapid charging is possible, and the operational efficiency of EV buses is improved. They won't need to travel long distance from one charge. As a result, the amount of batteries loaded per EV bus can be reduced and the electricity consumption can be improved.

#### Ultra Rapid Charging

To realize the operation of the Ultra rapid charging EV bus, There are two essential capabilities that a battery should have.

1. **Rapid charging** 2. **Long charge/discharge life**. The reason why a longer service life is also needed is that rapid charging improves battery operating rates, resulting in several times more charge/discharge cycles per day than in normal operation. Ultra rapid charging EV bus is a solution **that is only possible with SCiB™**.

#### Recruitment Results

More than 2,000 SCiB™-powered ultra-fast charging electric buses are in operation worldwide, mainly in Europe.

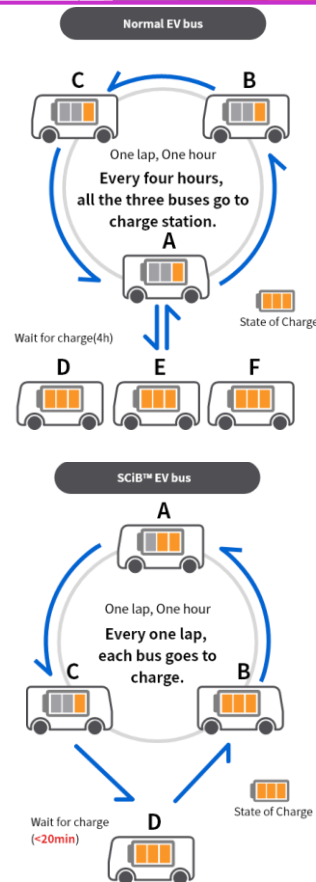

### Contact point

Toshiba Corporation Battery Business Dept.

Web inquiry form [Inquiry Form](#) | [TOSHIBA Rechargeable battery SCiB™](#)

PT. Toshiba Asia Pacific Indonesia

Mr. Agung Pratomo Subagio : +62 813 1757 1957, [agung\\_pratomo\\_subagio@tasia.toshiba.co.jp](mailto:agung_pratomo_subagio@tasia.toshiba.co.jp)  
(English / Japanese / Indonesian)



# 5. Energy Conservation

- **Low Carbon Solution for Industry**  
(PT. Mitsubishi Heavy Industries Indonesia)
- **Continewm**  
(Continewm Co., Ltd)
- **α-ESG(Fluid Stirring Device)**  
(ESG TECHNOLOGIES CO., LTD)
- **HERO - Hybrid Energy System Re-Optimization**  
(Toyo Engineering Co., Ltd)
- ***SUPERHIDIC*®**  
(Toyo Engineering Co., Ltd )
- **Control Solution for Building Energy Saving (ESCO)**  
(PT. Azbil Berca Indonesia)
- **Energy Saving Solution Service : ENEOPT™**  
(PT. Azbil Berca Indonesia)
- **Solutions and Products for Productivity and Sustainability**  
(SATO HOLDINGS CORPORATION)
- **Galilei Airtech System**  
(FUKUSHIMA GALILEI CO. LTD.)
- **ENERGY SAVING SOLUTION**  
(PT. MITSUBISHI ELECTRIC INDONESIA)
- **B to B Solution Provider**  
(PT RECOMM BUSINESS SOLUTIONS INDONESIA)
- **NATRUS<sup>+e</sup>W Pedestrian Flow Solution** **NEW**  
(Nabtesco Corporation      NABCO Automatic Door)

# Low Carbon Solution for Industry

EMS (Energy Management System), High-Efficiency Power Generator (Gas Engine, Fuel Cell), High-Efficiency Chiller, Waste Heat Power Generator, CO<sub>2</sub> Capture Technology

## PT. Mitsubishi Heavy Industries Indonesia

### Product and Service Outline

- ▶ Mitsubishi Heavy Industries (MHI) Group offers a wide range of technologies and solutions to realize decarbonization and low carbon society (energy transition, energy saving, electrification, CO<sub>2</sub> capture, etc.), that meet customer needs.
- ▶ CO<sub>2</sub> emission reduction has become an important managerial issue for each industry and factory in Indonesia. Although, Implementation of rooftop PV system is progressing, it is not necessarily effective depending on conditions such as limitation of power generation capacity and output fluctuation.
- ▶ CO<sub>2</sub> emission source is different for each industry and factory; therefore, it is the most important to analyze current conditions by each Scope and select appropriate solutions for CO<sub>2</sub> reduction. MHI Group supports CO<sub>2</sub> emission reduction on each Scope with the following solutions.

Scope-1 (direct emission) CO<sub>2</sub> capture unit

Scope-2 (indirect emission) Energy saving operation by EMS<sub>※1</sub>, high-efficiency chiller, in-house power generation by gas engine and fuel cell (SOFC<sub>※2</sub>), and power generation by waste heat recovery with ORC<sub>※3</sub>

- ▶ Furthermore, MHI Group offers solutions in view of future utilization of hydrogen and ammonia for in-house power generation,.

※1 Energy Management System ※2 Solid Oxide Fuel Cell ※3 Organic Rankine Cycle



EMS (Energy Management System)



High-Efficiency Chiller



Power Generation by Natural Gas / Hydrogen (Gas Engine, Fuel Cell)



Waste Heat Power Generation



CO<sub>2</sub> Capture Unit

### Experience and Example

- MHI Group has been offering low carbon solutions that suit diverse needs of various customers .
- The figure on the right shows an example that our customer achieved around 40% of CO<sub>2</sub> emission reduction by applying our engine power generation.
- In addition to engine power generation, MHI Group can offer established and reliable technologies and solutions shown below. With these technologies, MHI Group realizes CO<sub>2</sub> emission reduction and economical efficiency improvement of customers considering their ICP<sub>※4</sub> , an increase of electricity consumption and an introduction of PV system in the future.

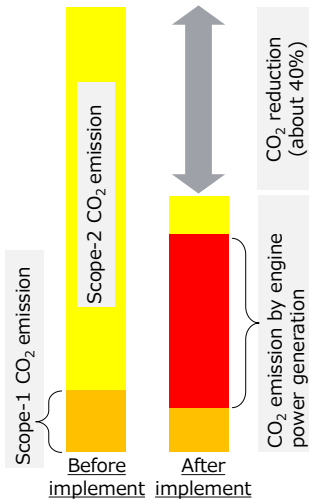

EMS : Control system used for thermal power plants which MHI Group constructed.

Engine Power Generation/High-Efficiency Chiller : Has a major share in the Japanese market.

CO<sub>2</sub> Capture : Has top market share in the world and has constructed world's largest plant in the US.

ORC : Abundant delivery records such as geothermal power plants, biomass power plants and waste heat recovery from factory furnace, etc.

※4 Internal Carbon Pricing

### Contact Person

—Phone number: +62 (0) 21-57974430

—E-mail address:

[kohei.matsunaga.4s@mhi.com](mailto:kohei.matsunaga.4s@mhi.com) (Japanese/English)

[achmad.hikam.ta@mhi.com](mailto:achmad.hikam.ta@mhi.com) (Japanese/English/Indonesian)

# CONTINEWM

The Realization for Electric Utility Expense Reduction with Low Cost and Easy Installation

## Continewm Co., Ltd

### Product and Service Outline

- ▶ With plus static electricity charge in air conditioner, [heat exchange efficiency] will be lowering because the air flowing won't become an airflow following the turbulence design, so it will spend some amount of electric power (electric power loss about 20%). By installing [continewm] to the existing air conditioning equipment (AC or chiller), the static electricity charge will be decreasing and then the heat efficiency will improve, it can preserve the temperature faster and longer on the set temperature, and finally, the compressor burden is lowering and that is the idea.
- ▶ During installation there is no need to reconstruct the existing equipment, only cleaning will be carried out and the installation or removal is easy. Moreover, after installation, there will be only periodic cleaning without running cost. The product durability will be years and for indoor use, it can be around 10 years (but it is no longer applied if there is a heat or pressure burden and used while bending).

### Actual Result and Example

- Our company business is to help [raising the value by ESG measure] toward the realization of a sustainable society. In short E's point of view in E (Environment), S (Social), and G (Governance), contributes to the strategy making for the climate change risk and handling.

<Actual result conducted within Japan>

\*some selection

Manufacturing industry :

- Denso Co., Ltd
- Totsuka denshi Co., Ltd
- Komatsu Co., Ltd
- Nippon mektron Co., Ltd
- Coca cola bottlers Japan Co., Ltd

The others :

- Toyota museum
- NTT east Japan Co., Ltd

<Actual result conducted overseas>

\*some selection

The others :

- Embassy of Canada (Thailand)
- Embassy of France (Thailand)
- Seto denshi Vietnam Co., Ltd (Vietnam)
- Jia tsun Industrial Co., Ltd (Taiwan)

### Contact Us:

Company name : PT. Toyota Tsusho  
Mechanical & Engineering Service  
Indonesia (TTME)

Location : MM2100 industrial park

Website : <https://www.ttme.co.id/>

—Contact person  
(Japanese)

Name: Kenji Tsunoda

E-Mail: [kenji\\_tsunoda@ttme.co.id](mailto:kenji_tsunoda@ttme.co.id)

Phone: +62-811-1902-9099

( Indonesian, English )

Name: Intan Wahyu Widaningrum

E-Mail: [intan.wahyu@ttme.co.id](mailto:intan.wahyu@ttme.co.id)

Phone: +62-811-875-6163

#### CONTINEWM® Specification

MADE IN JAPAN

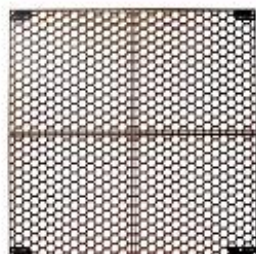

Size	1000x1000x20mm
Weight	300g
Color	Dark Brown
Shape	Rectangle (Max. width 1000mm, Min. width 100mm)
Material	Specific Clay Mineral, Low density polyethylene
Manufactured	Japan (Manufactured at a factory in Japan of a company based on the first section of the Tokyo Stock Exchange)
Manufacturer & Distributor	CONTINEWM Co., Ltd.
Patent Number	Pat. No. 5666464 (Academic guidance & Joint research) : Tokyo Institute of Technology, Kanagawa Institute of Technology
International patent application	PCT / JP2018 / 542347
Registration of design	No.2507440



Without CONTINEWM

With CONTINEWM

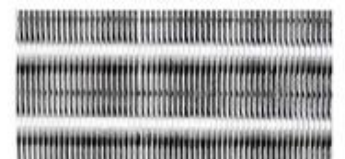



# Fluid Agitation Device “α-ESG” (Fluid stirring device)

Lowering Outdoor Machine Operating Rate and Reducing Consumption of Electric Power

## ESG TECHNOLOGIES CO.,LTD

### Product and Service Outline

- ▶ α-ESG is a fluid stirring device that reduces the flow resistance inside the pipe.
- ▶ By powerful stirring action it proceeds the liquefaction of freezer and refrigerator oil, reduces the flow resistance, and reduces the consumption of electric power by lowering the air conditioning, freezer, and refrigerator’s compressor burden, this is also a product that contributes to reducing CO<sub>2</sub>. The result will be different due to the environment and function of the equipment used, but the target is to reduce the consumption of electric power by about 10 to 30 %.
- ▶ The installation is just connecting it to the copper pipeline (liquid tube) that comes out from the outdoor machine, it is just a standard pipe construction. Moreover, there is no running cost because it is not using water or power, and the life span is the same as the standard pipe.
- ▶ But it is not possible to reduce the consumption of electric power on all kinds of air conditioning, refrigerator, and freezer.
  - Household and small-scale business purposes will be out of the subject.
  - If it is an air conditioning unit and in the condition of moving in as a tenant, then it will need permission from the management company.
  - Water-cooled, turbo type, and absorption type will be out of the subject.

### Actual Result and Example

- ESG technologies is a company that carries out environment, energy-saving, renewable energy-related products, and system planning, construction, and suggestion for companies that are serious about energy-saving and CO<sub>2</sub> reduction strategies.
- 「αESG」 had accepted the authorization as a system product and advanced equipment for advanced energy-saving investment facilitation support business on general incorporated association sustainable open innovation initiative (SII) 2021.

< Actual result conducted within Japan > \*some selection

Company name	Industry type	Area	Installation	Device	Air conditioning capacity	Reduction rate
			location			
NG kogyo Co., Ltd	Machine part production	Kanagawa	Production line	Air conditioning unit	28.00 kW	19.30%
Buil system Co., Ltd	Equipment manufacturing	Ibaraki	Examination room	Air conditioning unit	33.50 kW	30.20%
C-west Co., Ltd	Beverage production	Fukuoka	Product storage	Air conditioning unit	28.00 kW	21.30%
S Hospital	Hospital and facility	Shiga	Inside hospital	Air conditioning unit	61.50 kW	23.30%
T buhin kogyo Co., Ltd	Automobile component production	Aichi	Office	Air conditioning unit	45.00 kW	22.10%
K coffee	Restaurant	Fukuoka	Inside store	Air conditioning unit	22.40 kW	22.90%
N foof service Co., Ltd	Frozen food production	Chiba	Product storage	Freezer	56.00 W	21.10%
N group	Amusement center	Osaka	Hall	Air conditioning unit	553.00 kW	27.10%

### Contact Us:

Company name : PT. Toyota Tsusho  
 Mechanical & Engineering Service  
 Indonesia (TTME)  
 Location : MM2100 industrial park  
 Website : <https://www.ttme.co.id/>

– Contact person  
 (Japanese)

Name: Kenji Tsunoda  
 E-Mail: [kenji\\_tsunoda@ttme.co.id](mailto:kenji_tsunoda@ttme.co.id)

Phone: +62-811-1902-9099  
 ( Indonesian, English )

Name: Intan Wahyu Widianingrum  
 E-Mail: [intan.wahyu@ttme.co.id](mailto:intan.wahyu@ttme.co.id)  
 Phone: +62-811-875-6163

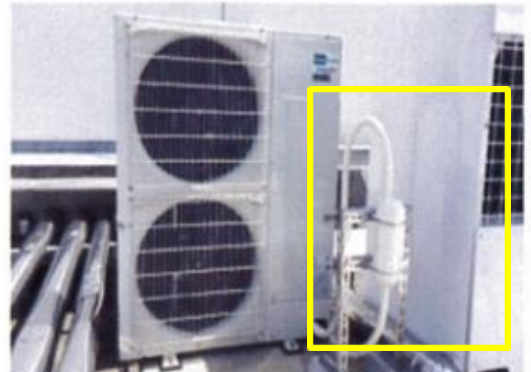



# HERO Hybrid Energy system Re-Optimization

TOYO Engineering Co., Ltd

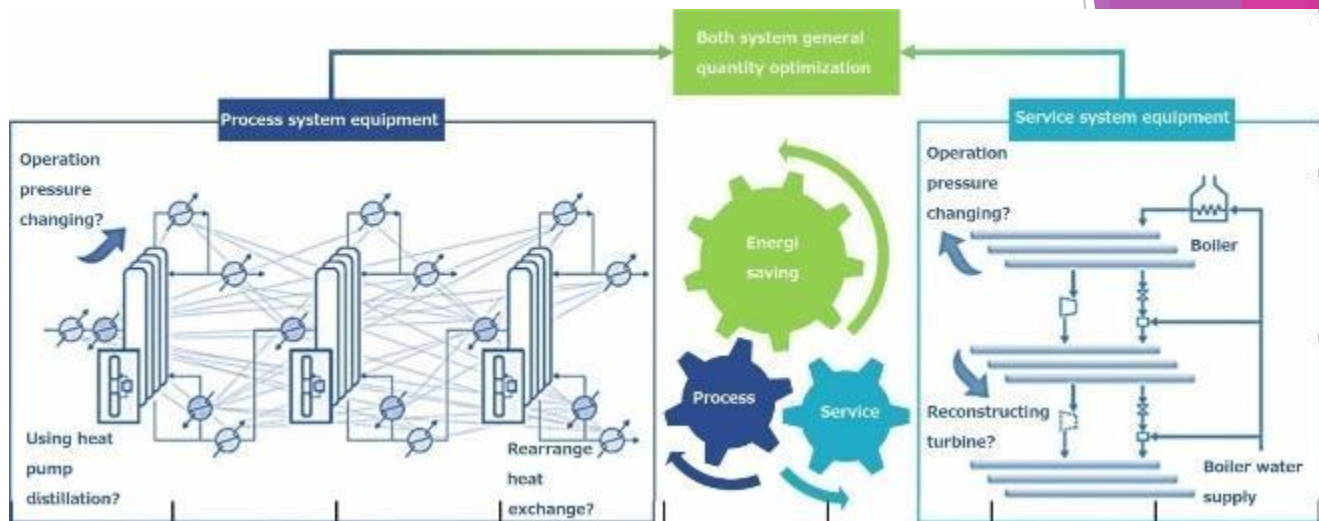

## Product and Service Outline

- ▶ HERO is a whole plant energy-saving consulting service. Realizing the optimization of service system and process system which has challenging barriers in the existing consideration rule, at the same time, according to quantity optimization technology. Giving the most suitable operation condition and required construction suggestion, following the customer request from the combination of several astronomical operation terms, design terms, and customer's characteristic limitation term. Even for a plant that has already performed high-grade energy-saving measures, a big energy-saving effect can be expected.

## Characteristic

### 1. Simultaneous optimization of Process and service system based on quantity optimization technology

- Constructing a big-scale model containing the whole plant. According to mixed integer linear programming, by discovering the complicated and huge trade-off relation, both system's same-time optimization can be realized.

### 2. Offering improvement options which are difficult in the existing consideration technique, along with process system and service system

- <Improvement option example on the processing system>
  - Operation pressure, temperature, and heat burden change
  - Conducting new heat exchange
  - Conducting heat pump technology such as *SUPERHIDIC*<sup>®</sup>
- <Improvement option example on the service system>
  - Steam supply pressure change
  - Changing the driving force steam of the steam turbine
  - Adding new steam header

### 3. Flexible suggestions comply with the customer's business environment

- In HERO, a specialized personal optimization model is being constructed for each customer. Because of that, it is possible to offer a line-drawn improvement plan with general purpose technology consideration.
- Not only the equipment special characteristic, by including the most suitable model such as investment requirement, limitation related to improvement and operation idea, the energy saving plan that comply with customer's request can be offered.

## Actual Result and Example

There are total of 5 conducted consideration has been carried out inside and outside Japan, mainly for petrochemistry plant. Several projects are in progress toward equipment improvement operation based on the optimization suggestion obtained according to the most suitable consideration

### Example (an aromatic plant)

Consideration effect example

- Steam consumption reduction: >25 ton/year (>20 %/year reduction)
- Fuel gas reduction: equivalent to 1.5 MW
- Increase in power generation consumption amount : slight increase (additional pump part)

## Contact Us:

TOYO Engineering Corporation  
 Plant Solution Business Unit,  
 Advanced Technology Business Department  
 Tel: +81-47-454-1571  
 E-mail: [toshihiro.wakabayashi@toyo-eng.com](mailto:toshihiro.wakabayashi@toyo-eng.com)  
 Web site: <https://www.toyo-eng.com/jp/>

## TOYO Engineering Co., Ltd

### Product and Service Outline

▶ Through many services of petrochemistry and oil refinery, more than 50% energy saving performance can be secured. Without using any special equipment, by applying to the existing distillation technology, the GHGs reduction effect can be offered due to energy shift from heat to electricity and the high economic saving, while preserving the existing maintainability.

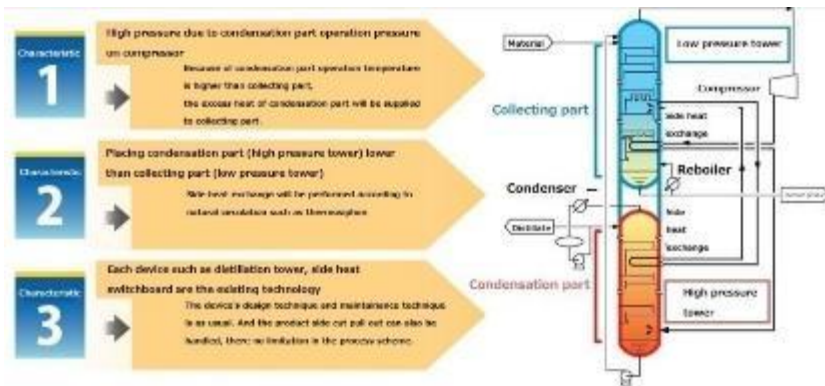

### Applied subject

Whether the existing improvement or new establishment can be expected to have a superior economic effect, by the following distillation tower.

- The tower top and tower bottom operation temperature is within 80°C
- Using a highly-priced service
- Having a condenser burden, and reboiler burden that can receive the advantage of scale
- Process unit example that can secure a big energy-saving performance, by using **SUPERHIDIC®**

### Actual Result and Example

**SUPERHIDIC®** which can realize ultimate energy saving form in distillation operation is used by Maruzen Petrochemical Co., Ltd alcohol ketone device in 2014, as a contribution target in energy saving advancement and greenhouse effect gas emission amount reduction, then starting the business operation in 2016 and has been running well.

Established country	Japan
Process unit	Alcohol ketone production equipment
Processing amount	21kL/h (Materials flow amount)
Conventional type distillation tower's energy consumption amount	6.3MW
Energy saving rate	50%+

Moreover, a high rating has been obtained from the industry-academic government, as shown in the following

- 2014 24<sup>th</sup> Nikkei global environmental technology award, excellence award
- 2018 Energy saving grand prize (Ministry of economy, trade, and industry, Minister's award)
- 2018 Chemical engineering association technology award
- 2022 Certified in advanced equipment and system, at General incorporated association, environmental co-creation initiative advanced energy-saving investment promotion support project cost subsidy. Et cetera

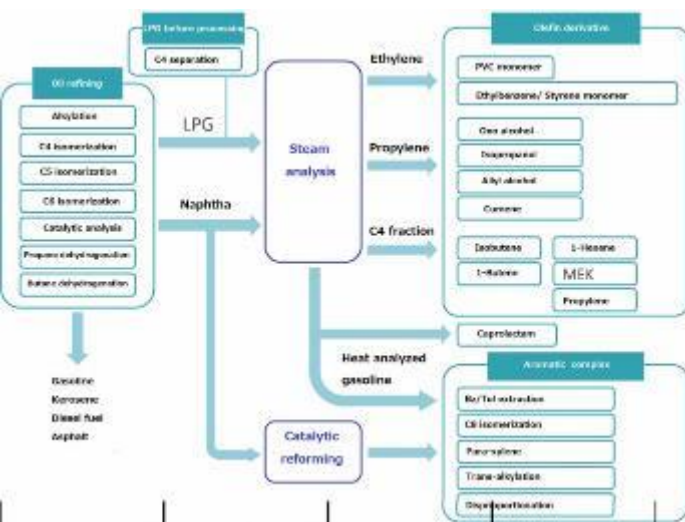

### Contact point

TOYO Engineering Corporation  
 Plant Solution Business Unit,  
 Advanced Technology Business Department  
 Tel: +81-47-454-1571  
 E-mail: [toshihiro.wakabayashi@toyo-eng.com](mailto:toshihiro.wakabayashi@toyo-eng.com)  
 Web site: <https://www.toyo-eng.com/jp/>

# Control solution for building energy saving (ESCO)

Energy saving in building HVAC, with initial investment reduction by ESCO scheme

## Azbil Corporation/PT. Azbil Berca Indonesia

ESCO

Energy Service  
Company

A business that provides comprehensive services to realize energy saving in buildings and receives service-remuneration from the actual energy saving performance.

Site Check

Proposal

Contract

Installation

Guarantee



Energy saving in HVAC, which consumes a large amount of energy consumption in Bldg.

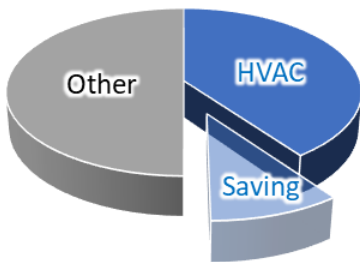

Providing unique energy-saving methods with utilizing high-efficiency equipment, optimal operation control or tunings for the entire facility, and monitoring system (BMS).

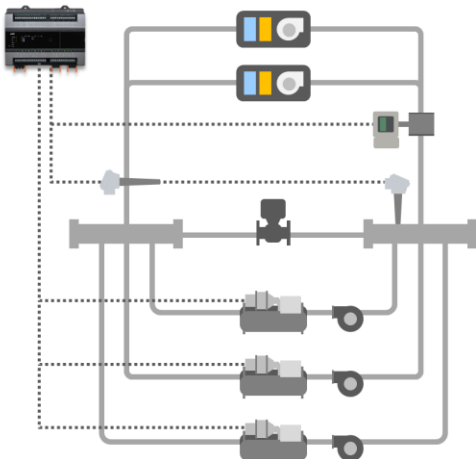

### Product and Service Outline

#### ▶ Optimization of overall facility operation

- ▶ For larger energy savings, we not only install high-efficiency equipment that is common in Bldg. energy savings, but also optimize the overall operation of HVAC equipment with a control & monitoring system (BMS) and tuning service.

#### ▶ No initial investment with Lease financing

- ▶ Initial investment will be unnecessary, if lease financing can apply in ESCO scheme (Depends on the potential of energy saving through site surveying.)

#### ▶ Energy saving performance guarantee by Azbil

- ▶ Azbil guarantees energy saving performance when utilize ESCO scheme
- ▶ Azbil will compensate the unachieved amount, if not achieve the saving performance target.

#### ▶ Long-term Support

- ▶ Report quarterly with advices until ESCO term completion.
- ▶ No worries regarding BMS system maintenance because that maintenance is packaged in ESCO service scope.

### Actual Result

- ▶ 250+ ESCO projects in Japan
- ▶ 50+ energy-saving projects in Indonesia
- ▶ Samples of ESCO result in Indonesia
  - ▶ Complex building 1,920 MWh down in annual
  - ▶ Shopping mall 1,260 MWh down in annual
  - ▶ Machinery factory 630MWh down in annual

**Contact point** PT.Azbil Berca Indonesia (Building Automation Div.)

E-Mail : [azbil.ba@id.azbil.com](mailto:azbil.ba@id.azbil.com) Phone : +62-21-230-5538

Inquiry Form : <https://berca.azbil.com/ContactUs/contact.html>

# Energy Saving Solution Service : ENEOPT™

for Energy Conservation to Contribute Sustainable CO<sub>2</sub> Reduction

## Azbil Corporation/PT. Azbil Berca Indonesia

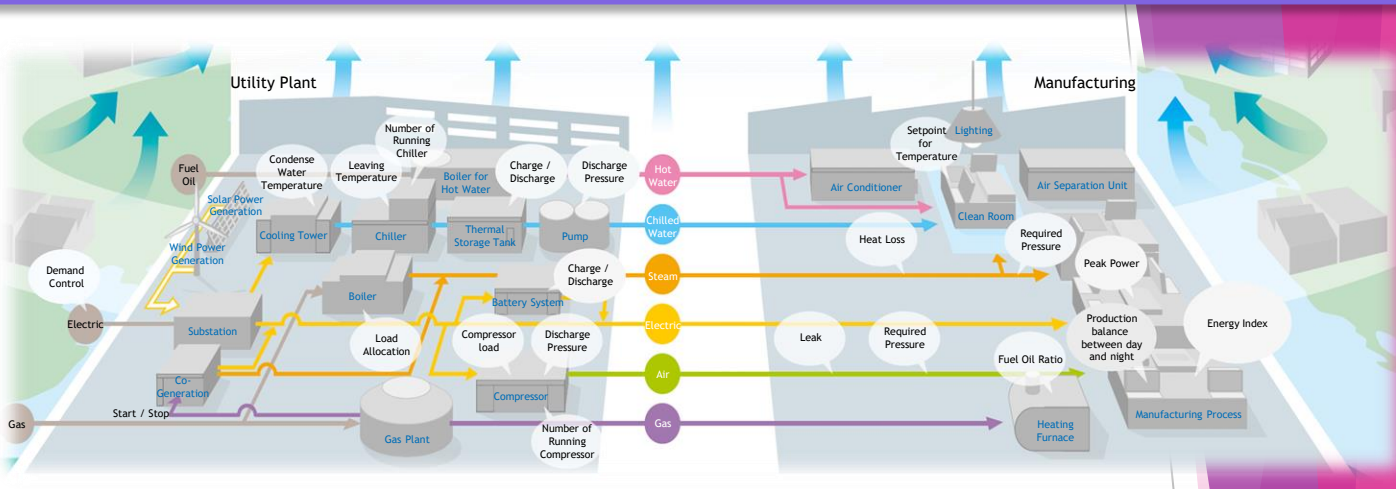

### Product and Service Outline

- ▶ ENEOPT is one of **energy conservation solutions** towards a decarbonized society by Optimization Control.
- ▶ The target applications: ENEOPT is energy-saving improvement support system that minimizes CO<sub>2</sub> emissions and energy costs of **Utility Plant** such as Boiler, Turbine facilities.
- ▶ General step for **ENEOPT solution service**.
  - ✓ **Step1:** Find Opportunity for Energy Saving from Operation Improvement
  - ✓ **Step2:** Feasibility study to estimate CO<sub>2</sub> reduction by using actual operation data
  - ✓ **Step3:** ENEOPT System Installation/Customized and set up to suit customer's plant's need.
  - ✓ **Step4:** Operational support and maintenance services by Azbil to ensure the performance of ENEOPT

### Actual Result and Example in Indonesia Oil Refinery

- ◆ This was one of three demonstration projects in Indonesia for the Joint Crediting Mechanism (JCM), organized by Japan's New Energy and Industrial Technology Development Organization (NEDO).
- ◆ Azbil control technology at a power plant to **optimize boiler operation**, and succeeded in reducing CO<sub>2</sub> emissions
  - ✓ Optimized boiler system operation cuts appx. **35,000 tons/year** of CO<sub>2</sub> emissions  
(Implement at Boiler-Utilities Plant in PT Kilang Pertamina International-Pertamina RU IV Cilacap)

ENEOPT is a trademark of Azbil Corporation.

#### Contact point

PT. Azbi Berca Indonesia (Industrial Automation Dept. Team)

—E-mail address : [Info\\_IA@id.azbil.com](mailto:Info_IA@id.azbil.com)



## SATO HOLDINGS CORPORATION

### Product and Service Outline

- ▶ SATO is a global auto-ID solutions provider for various industries. We tag every 'thing' using RFID and barcode technologies, make the most of data and derive the best solution for each unique site. SATO has 82 years of expertise with 5,600+ employees across the globe (as of Mar 2022).
- ▶ SATO has business presence in over 90 countries/regions. We engineer and produce hardware (label/tag printers) and consumables (labels and stickers), develop and integrate solutions, and provide maintenance services.
- ▶ Our mission is to "contribute towards a better and more sustainable world." We resolve societal challenges by offering solutions for accuracy, labor- and resource-savings, safety and reassurance, sustainability and emotional connections.

#### Example I Automation of shipping processes

We offer a full range of products that support shipping processes: barcoded shipping labels, label printers and barcode scanners, and software to control these devices.

Our auto-labeling systems in particular apply labels faster and with greater precision compared to manual labeling. Operation efficiency leads to labor savings and reduction of carbon emissions.

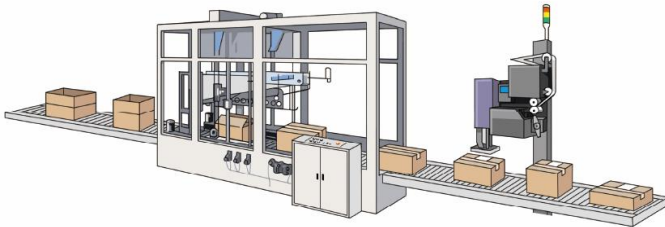

#### Sample case

Expected benefits\*<sup>1</sup> from automating carton sealing & measuring and label printing & application:

- ✓ **Productivity: Up 2.2 folds**
- ✓ **Labor saved: 40%**
- ✓ **CO<sub>2</sub> emissions cut: 14 tons/year\*<sup>2</sup>**

\*1 Estimations are derived by multiplying worker-hour savings by an emission factor associated with the customer's industry, and **do not guarantee the amount of actual reduction.**

\*2 Calculation method was developed under supervision of relevant authorities and experts.

#### Example II Linerless labels



We develop products addressing environmental concerns. Linerless labels are an example.

Linerless labels save wood pulp material and energy consumption in production, while reducing liner waste.



As a single roll comes with about 40% more labels than standard rolls, it reduces shipping and storing costs.

We have a selection of label printers that are compatible with linerless labels.

#### Sample case

Expected benefits\*<sup>3</sup> from replacing 200,000 labels of 4 x 7 cm with linerless labels:

- ✓ **Waste reduced: 78 kg**
- ✓ **CO<sub>2</sub> emissions cut: 196 kg**

\*3 Estimations are calculated with certain conditions set by SATO.

SATO Official YouTube page





# Galilei Airtech System

PMV control using AI technology

FUKUSHIMA GALILEI CO. LTD.

## Product and Service Outline

- ▶ Reducing energy costs, improving in-store environments, and increasing productivity by improving air-conditioning ventilation methods in supermarkets and other stores.
- ▶ Utilizing the air conditioning system with separation process of latent heat and sensible heat, a desiccant air conditioner is introduced for latent heat treatment, and a high sensible heat air conditioner is introduced for sensible heat treatment.
- ▶ Comfortable and energy-saving store environment will be achieved by controlling the positive pressure inside the store and supplying dehumidified air from the bottom of the showcase.
- ▶ The air-conditioning load due to ventilation in summer can be reduced by 70%, and the load on refrigeration equipment can be reduced by 20%.
- ▶ Automatic optimization maintains a comfortable store environment and contributes to labor saving. This system is a system suitable for the "with-corona" era, contributing to energy saving with proper ventilation.

## Actual Result and Example

At a supermarket (3,800m<sup>2</sup>)  
[Energy saving effect]

- More than **20% reduction in power consumption** in summer from conventional system (See figure on the right).
  - Annual energy saving effect : around 370 juta IDR
  - Additional Equipment cost : around 1 milyar IDR
  - Payback period : around 2.9 years
- [In-store environment] in front of showcase
- Benchmark store: temperature (21°C) and humidity(93%)



- Store with **Galilei Airtech System**
- Temperature (24°C) and humidity (47%) (comfortable)

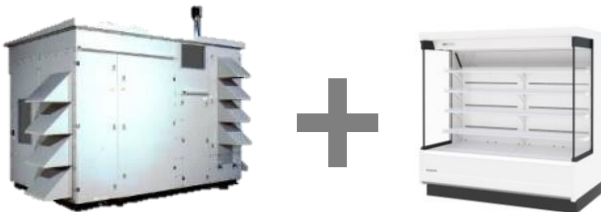

※The figures based on the data from examples in Japan.

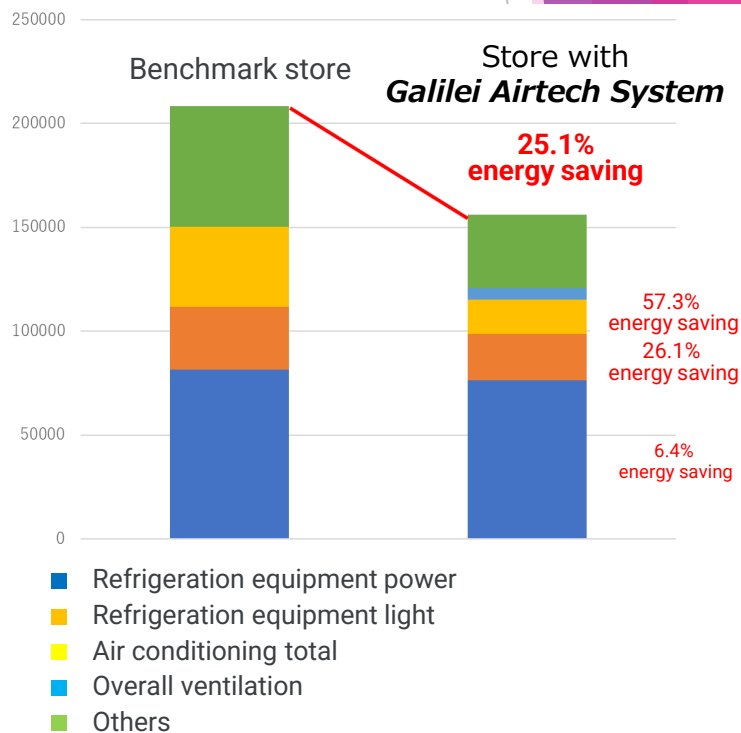

## Contact point :

PT. FUKUSHIMA GALILEI INDONESIA

(Phone) : +62-21-27095619 (Mr. OOSUGI: English and Bahasa)

(E-mail) : oosugi.kaz@galilei.co.jp ( Mr. OOSUGI : English and Bahasa)

# ENERGY SAVING SOLUTION

Solutions that contribute to decarbonization by discovering and reducing wasteful energy

## PT. MITSUBISHI ELECTRIC INDONESIA

### Product and service outline

- ▶ We support the reduction of CO<sub>2</sub> emissions by promoting energy conservation in buildings, factories, etc. We have a variety of equipment and applications necessary for this purpose.

<PDCA process for factory energy saving>

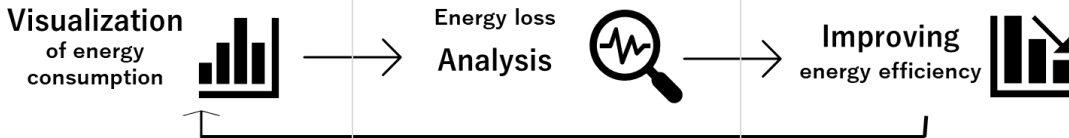

< Main equipment used for factory energy saving and operational improvement >



### <Ex. Energy saving management system configuration>

#### Ex. For office buildings

- Easy management with EcoWebServer
- Automatic control according to usage conditions

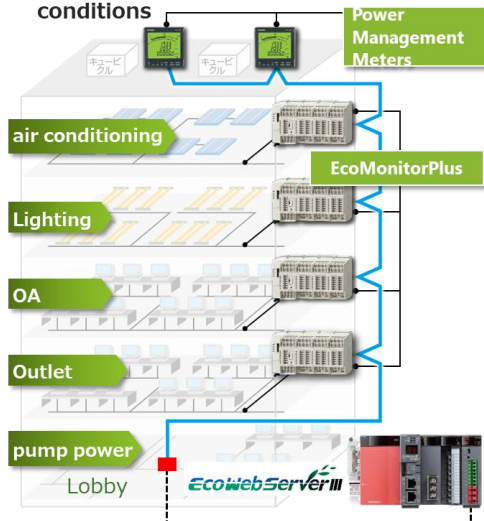

Example of effect  
Office power consumption reduced by 24% (2.8t-CO<sub>2</sub>)

#### Ex. For production line

- Collect detailed production and energy information

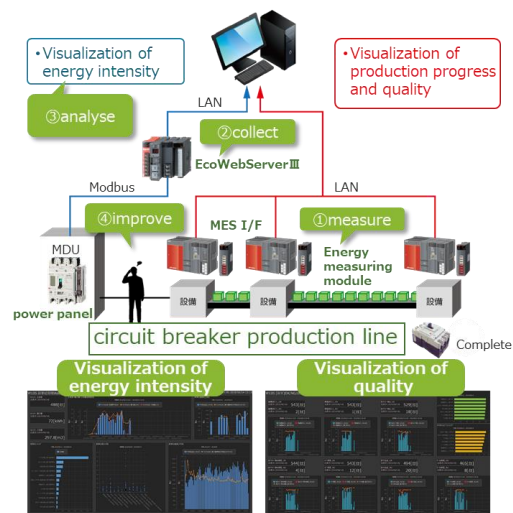

Example of effect  
Energy intensity reduced by 30%

### Contact point

PT. MITSUBISHI ELECTRIC INDONESIA

— Phone number : +62-21-31926461 (English/Indonesian available)

— E-mail address : [MEIN.FAID@asia.meap.com](mailto:MEIN.FAID@asia.meap.com) (Japanese/English/Indonesian available)

# B to B Solution Provider

## Providing Carbon Neutral and Cost Reduction Solutions

### PT RECOMM BUSINESS SOLUTIONS INDONESIA

#### Product and Services Summary

Since July 2019, PT RECOMM BUSINESS SOLUTIONS INDONESIA has been developing solutions for customers that have carbon neutral program, mainly with following proposal:

► Carbon Neutral and Cost Down Solutions

Providing carbon-neutral and cost-cutting solutions that reduce CO<sub>2</sub> emissions and SG&A expenses such as electricity bills through the effects of new LED lighting.

### Carbon Neutral Solutions Further Implementation

#### Low Energy Consumption Devices

#### Result



Low Energy Consumption

Eco-friendly

- Limited variety of mass-produced original brand products
- Wide variety of national brand around 50,000 items

- Low energy consumption and large CO<sub>2</sub> emission reduction
- Providing products that match the area and installation environment of factories and offices

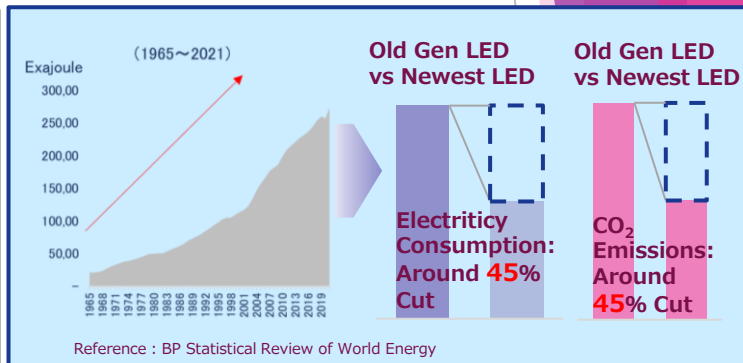

Proposing Carbon Neutral Solutions, Contributing to electricity bills and CO<sub>2</sub> Emission Reduction

#### Result and Example

【LED】 Our original brand products are designed to consume significantly less electricity than conventional LED lightings, with a long warranty period of 5 years. Therefore, around 520 Japanese companies in Indonesia already have been using our products.

#### Contact Us:

PT. Recomm Business Solutions Indonesia

- Atsugi Dai : +62 811 2555 631
- Akbar Andika Gumay : +62 813 1316 8827

[d.atsugi@recomm.co.jp](mailto:d.atsugi@recomm.co.jp)

[andika.gumay@recomm.co.jp](mailto:andika.gumay@recomm.co.jp)

## Product and service outline

- NATRUS<sup>+</sup>e W is equipped with two sensors (infrared ray sensor and image sensor) for detection. By utilizing these two types of sensors, the pedestrian flow detection area has been made around four times larger than the conventional one, making it possible to reliably detect the pedestrian flow in a wider area. This allows the automatic doors to open precisely at the right time for smooth entry and exit.
- Detecting the movement of both people and objects (wheelchairs, baby chairs, carts, etc.), makes it very suitable for barrier-free facilities such as stations, commercial facilities and educational institutions.
- Reducing unnecessary automatic door openings helps to minimize energy loss and improve the indoor environment of buildings.

More information: [https://nabco.nabtesco.com/en/nabco-select/natrus\\_ew/](https://nabco.nabtesco.com/en/nabco-select/natrus_ew/)

## Actual Result and Example

- To verify the effectiveness of this product, we conducted a demonstration installation at the entrance of the "NEOPASA Suruga Bay Numazu" service area on the Shin-Tomei Expressway.
- Previously, there were frequent unnecessary door openings due to high pedestrian traffic. However, after the installation, the door's opening time was reduced by approximately 21% compared to our conventional sensor-equipped automatic doors \*1, and there was also an improvement in pedestrian flow of about 20% \*2 (according to our research).

\*1 Sensor that detects the entry of objects into the sensor area and signals the door to open.

\*2 The percentage of doors opening faster than with conventional sensors, based on pedestrian flow.



Pedestrian flow detection to determine if the doors will open or not.

Image Sensing W

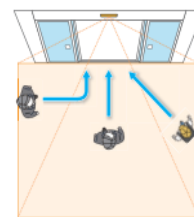

The doors will open.

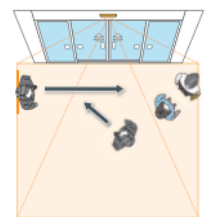

The doors will not open.

## Contact Point

Nabtesco Corporation Marketing & Sales DEPT. Yuchun Deng

Mail : [Yuchun\\_Deng@nabtesco.com](mailto:Yuchun_Deng@nabtesco.com) Tel: +81 3-5213-1156

HP : <https://nabco.nabtesco.com/en/>

## 6. Utilization of digital technology

- **MaaS ~ Mobility as a Service ~**  
(PT. Nagase Impor-Ekspor Indonesia)
- **Plant Operations Digital Transformation Solution**  
**EFEXIS®**  
(CHIYODA Corporation)
- **Operation Optimization Navigator LNG Plant AI**  
**Optimizer™**  
(CHIYODA Corporation)
- **Climate Cloud Platform for Measuring CO<sub>2</sub> Emissions**  
(Asuzero Singapore Pte. Ltd.)
- **GHG Emission Calculation Cloud Service**  
(Zeroboard Inc.)
- **IT Solution for Transport Management**  
(Zenmov Inc.)
- **Digital Twin System for Chiller Plant (CPDT)**  
(Azbil Corporation/PT. Azbil Berca Indonesia)
- **Power Usage Visualization Solution**  
(PT. KDDI INDONESIA)



### PT. Nagase Impor-Ekspor Indonesia

#### Product and service outline

- ▶ Making full use of advanced algorithm which use AI/Cloud that has been proven in European, American, and ASEAN countries, we provide a Telematics service for business and corporation that can contribute on cost improvement, distribution efficiency, fuel consumption improvement, labor cost reduction, improvement of driving propensity, accident reduction, insurance premium reduction, and CO<sub>2</sub> emission amount reduction, et cetera.
- ▶ The service is easy to be implemented and can be operated only by installing our company application on the driver's smartphone. \*As for the special data service, the device needs to be installed in the car.
- ▶ The UI/UX supports 4 languages (Japanese, English, Thai, and Indonesian) , therefore operations from both the management and staff can use this service smoothly.
- ▶ The CO<sub>2</sub> emission is calculated on the application based on the vehicle model, year, driving propensity, cruising distance, and fuel consumption, and the results are provided in real time.
- ▶ Various analyzed data, reports, and feedback for improvement can be provided in a real time manner based on our 3 main service which are Fleet Management System, Drive Insight and Drive Safe.
- ▶ With software that supports expandability, this allow our system to be combined and integrated with the customer's existing system.

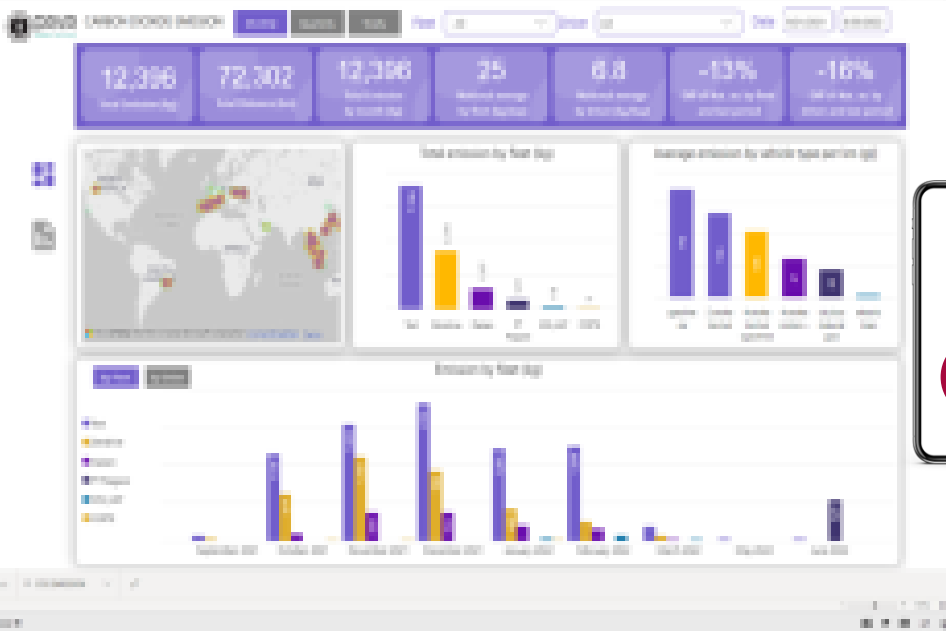

#### Contact point

PT. Nagase Impor – Ekspor Indonesia  
Mobility Solutions Division,  
Yuhei Suzawa (Japanese and English)  
Tell : +62-815-1018-7797  
E-mail : [Yuhei.Suzawa@nagase.co.jp](mailto:Yuhei.Suzawa@nagase.co.jp)  
Josua Siagian (Bahasa Indonesia and English)  
Tell : +62-815-901-9503  
E-mail : [josua@nagase.co.id](mailto:josua@nagase.co.id)

#### Actual result and example

- Our company has experience with multiple companies in the US, Australia, and ASEAN region, especially for Automotive OEM, Insurance industry, logistics industry, and public transportation. In Indonesia, we are conducting PoC with several companies and full deployment of our service will start in October 2022.

#### Target industry

- Logistics industry, insurance industry, lease and rental industry, car maker, automobile dealer, et cetera.

## CHIYODA Corporation

### Product and Service Outline

- ▶ EFEXIS®, the brand name of Chiyoda's innovative digital solution, improves the productivity and stability of industrial facilities.
- ▶ We provide solutions in the form of optimization, stabilization, safety, remote control, labor saving, and visualization for the operation, maintenance, and security of your plant.
- ▶ By using the EFEXIS® solution, you can improve productivity by optimizing plant operation, reduce costs for operation, maintenance, and safety, and reduce environmental impact without major equipment modifications.

### Actual Results and Use Cases

#### PLANT AI Optimizer

- Installed in LNG facilities and Oil Refineries

#### Abnormal detection AI

- Installed in LNG facilities

#### Remote monitoring and diagnose system

- Installed in Oil Refineries

#### Automation & autonomy operation system

- Proven in Oil Refineries

### Boost Performance Reduction of OPEX, De-carbonization

EFEXIS™ PLANT AI OPTIMIZER  
Increase productivity  
Reduce environmental impacts

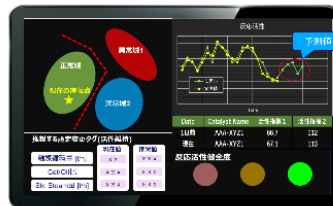

EFEXIS™ CDU Optima  
Automation & Autonomy Operation



### Improvement of Utilization

EFEXIS® Anomaly Prediction AI system  
Early detection of abnormal operation and failure of equipment

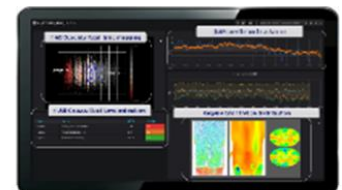
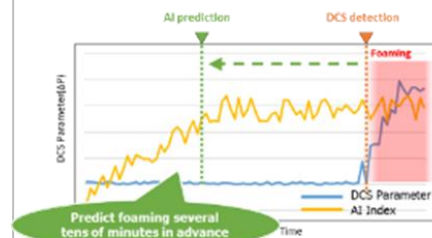

### Contact point

CHIYODA Corporation  
+81-45-225-4725

Digital Marketing Section  
[digital@chiyodacorp.com](mailto:digital@chiyodacorp.com)

# Operation optimization navigator LNG Plant AI Optimizer™

## CHIYODA Corporation

### Product and Service Outline

- ▶ The demand for liquefied natural gas is expected to increase significantly in the future due to the increase in global energy demand and in response to environmental issues. In addition, reduction of LNG production cost is strongly required.
- ▶ It is possible to safely increase LNG production and improve economic efficiency without physical modifying plant facilities based on our experience in LNG plant engineering, procurement, and construction, combined with innovative AI technology.

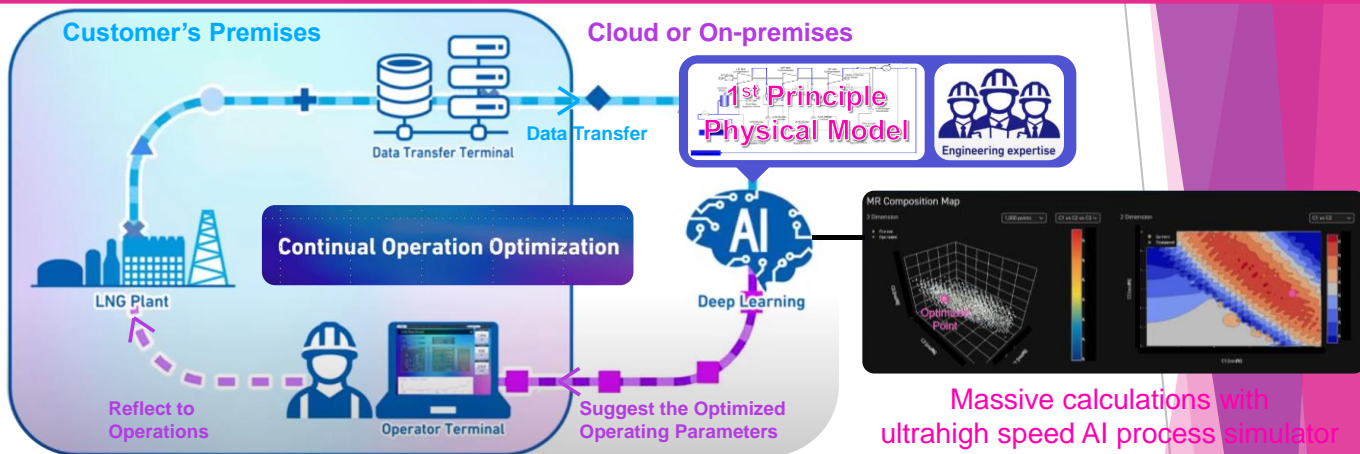

### Actual Results and Use Cases

For the PT Donggi-Senoro LNG plant in Indonesia, we confirmed increased LNG production through improved efficiency by using the "LNG Plant AI Optimizer™".

- ▶ Increased earnings through up to 5% increase in annual LNG production.
- ▶ Contribution to Fuel Gas Saving (Energy Saving) and up to 5% reduction of CO<sub>2</sub> emissions.
- ▶ No modification of plant facilities or installation of additional equipment is required. The system can be installed and operational in a very short period of time. The system can be introduced without changing the current plant operation methods and operators.
- ▶ The system has a learning function that continuously improves the efficiency of plant operation.

### Contact point

CHIYODA Corporation  
+81-45-225-4725

Digital Marketing Section  
[digital@chiyodacorp.com](mailto:digital@chiyodacorp.com)



Product Movie

# Climate Cloud Platform for Measuring CO<sub>2</sub> Emissions

## Asuene APAC Pte. Ltd.

### Product and Service Outline

- To take actions on climate change and sustainability, as the first step, measuring GHG emissions to understand the current situation is required.
- Asuzero, a climate cloud platform for enterprises to measure GHG emissions, can reduce man-hours for calculation by up to 70% and provides a one-stop solution including lectures of calculation methods, goal settings and also consultation for reducing CO<sub>2</sub> emissions.



#### FEATURE 01 AI-OCR & High Accuracy

- AI-OCR scan and visualize: Automatic calculation and intuitive user-friendly experience
- Highly accurate and reliable: Certified according to ISMS and ISO14064-3\*1

#### FEATURE 02 CDP Accredited Consultation

- Not only cloud platform, but also offering comprehensive sustainability consultation to reduce CO<sub>2</sub> emissions and report according to global initiatives, such as TCFD and CDP

#### FEATURE 03 One-stop solutions for decarbonization

- Support for energy efficiency, energy creation and carbon offset with our partners

### Track Record

- 4,000 customers
- Working across various industries such as manufacturing, construction, real estate, logistics, transportation and finance

### Customers

- Obayashi Corporation (the major construction company headquartered in Japan)
  - Succeeded to visualize GHG emissions of each construction site
- ST Engineering (the technology and engineering company headquartered in Singapore)
  - Succeeded to unify the method of calculating GHG emissions of each entity throughout the global supply chain



### Contact Point

PT. Asuene APAC Pte. Ltd.

—Phone number : (65)92997662 (Shu Setogawa : English)

(81)5017900593 (Yuna Sato : Japanese)

—E-mail address : [sg-sales@asuzero.com](mailto:sg-sales@asuzero.com) (Yuna Sato : English / Japanese)



# GHG Emission Calculation Cloud Service

Transforming Climate Change into Social Possibilities  
~ Working diligently to solve the shared challenge of climate change ~

## Zeroboard Inc.

### Product and service outline

The calculation and visualization of greenhouse gas (GHG) emissions not only improves corporate value but also contributes to cost reductions. Zeroboard is a cloud service that calculates GHG emissions according to international rules and manages efforts to reduce GHG emissions.

#### ▶ **Reliable**

Verified to follow ISO14064-3 calculation standards  
Zeroboard is ISMS (ISO27001) certified

#### ▶ **Track Record and Usability**

With over 2,600 companies already using our product, zeroboard has a solid reputation for ease of use based on customer feedback.

#### ▶ **Network Effect**

Ability to acquire and link primary data from suppliers, harnessing the network-effect to create a rapidly growing ecosystem.



### Actual result and example

Zeroboard is used by a wide range of companies ranging from large cap to SMEs who are required to disclose their Scope 1-3 GHG emissions.

Used by  
**Over 2,600**  
companies

#### Companies committed to decarbonizing operations with Zeroboard

### Contact point

Zeroboard (Thailand) Co., Ltd. (Mr. Suzuki: English support)

—E-mail address : [shintaro.suzuki@zeroboard.jp](mailto:shintaro.suzuki@zeroboard.jp)

# IT Solution for Transport Management

Bringing order to traffic with our cloud-based fleet management system “SMOC”

Zenmov Inc.

## Product and service outline

Our proprietary cloud-based fleet management system “SMOC” transforms chaotic traffic into organized and disciplined traffic

1. The system allows for monitoring vehicle operation status and management of vehicle dispatch according to the situation. (solving the demand-supply imbalance)
2. The vehicle interval adjustment function enables keeping intervals in equal moments. (optimal allocation of vehicles according to travel demand and environment in the area)
3. The system automatically creates drivers' schedules and visualizes each driver's performance, enabling the operators to have the most efficient transport management.
4. Low vehicle utilization rates can be solved by implementing management of operational modes tailored to the transportation demand.
5. The complexity of equipment management can be simplified by incorporating device management and fleet management functionalities

(1) Schedules automatically generated by the data collected



(2) Adjust the intervals which would be inevitable without our system

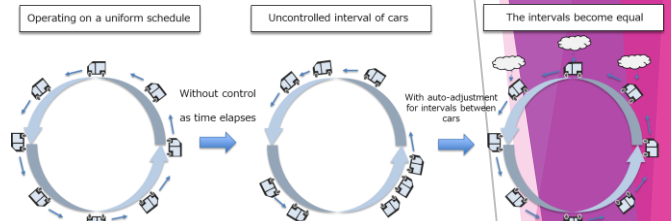

(3) Discrepancy of actual work hours and scheduled hours is visible



(4) Different Operation modes according to the demand

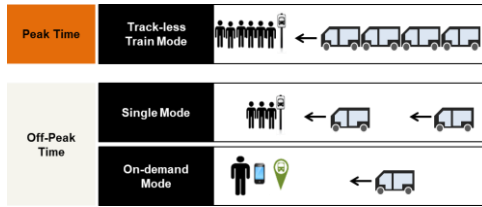

(5) One system manages all vehicles

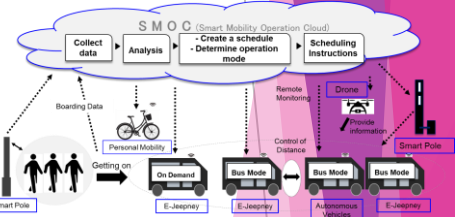

## Achievements

- Providing the service to the transport operator (Jeepney Operator) in the Philippines
- “Demonstration Project for Smart Mobility for New Clark City and the entire Clark Economic Zone” Philippine, Clark Area, funded by NEDO
- “Creation and dissemination of low-carbon emission technologies through co-innovation” at Pasay City, Philippines, funded by the Ministry of the Environment, Japan
- “FY2022 Smart JAMP Research and Study for the Realization of Smart Cities in Bandar Seri Begawan, Brunei Darussalam,” funded by the Ministry of Land Infrastructure Transport and Tourism Japan



In-vehicle monitor for passengers



Passengers waiting for the buses in Brunei



Monitor installed at the doorway of the Ministry of Transport and Infocommunications in Brunei

## Contact point

Zenmov Inc. (Yukari Fuchi: English and Japanese)

—Phone number : +81-90-3455-9904

—E-mail address : [info@zenmov.com](mailto:info@zenmov.com) (English and Japanese)

# Digital Twin System for Chiller Plant (CPDT)

AI adaptive-cooling and machine-learning actionable insights redefine smart building management and characterize the initiatives of Green Building Masterplan.

Azbil Corporation/PT. Azbil Berca Indonesia

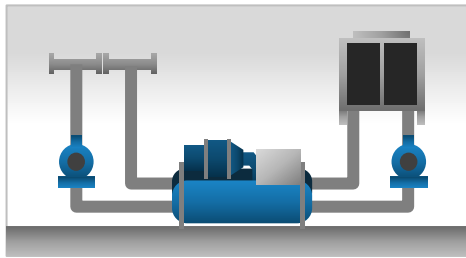

Physical Chiller Plant

Machine learning using real-time operational data.



Incorporating AI-driven analytical results.

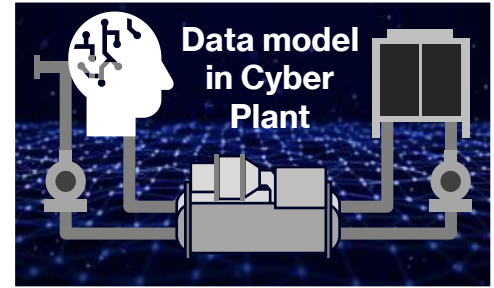

## Product and service outline

The CPDT digital simulator is a valuable tool for optimizing the operation of building chilled water systems and achieving energy savings.

CPDT AI engine creates an accurate virtual space that adjusts to changing conditions and degradation using machine learning. By utilizing this virtual space, users receive optimal operating plans that align with their facility management strategies, leading to optimal operation of the chiller plant.

- ▶ **Data Visualization**
  - ▶ Identify current usage status with various Dash Boards
- ▶ **Optimization & Evaluation**
  - ▶ Trial & Error in the cyber space for Energy-saving operation
- ▶ **Judgement Enhancement**
  - ▶ Operational fault detection by Comparison with ideal status
- ▶ **Operation Enhancement**
  - ▶ Actionable insights, Operational Advice

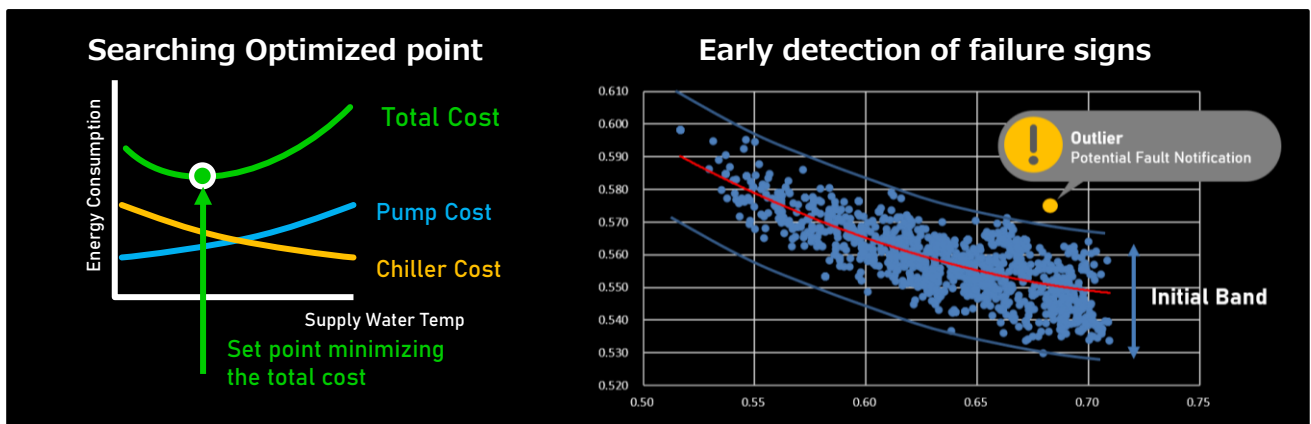

Contact point PT.Azbil Berca Indonesia (Building Automation Div.)

- ▶ E-Mail : [azbil.ba@id.azbil.com](mailto:azbil.ba@id.azbil.com) Phone : +62-21-230-5538
- ▶ Inquiry Form : <https://berca.azbil.com/ContactUs/contact.html>

# Power Usage Visualization Solution

## First Step to Decarbonization

PT. KDDI INDONESIA

### Product and service outline

- ▶ First and most important initiative to achieve decarbonization is to understand the current situation. Even if we can grasp the amount of electricity used in our entire office/factory/warehouse, almost many companies do not know the detailed consumption amount at the actual production site.
- ▶ Visualizing power usage is a very useful action for not only understanding the current position, but also for checking the status of equipment and improving energy consumption efficiency. We KDDI Indonesia uses ICT to support the visualization of electricity usage in offices and factories as a first step toward decarbonization.
- ▶ By utilizing both wired and wireless networks, we can collect data from any location and build a flexible "visualization platform" tailored according to size and environment of offices, factories, warehouses, etc.
- ▶ Visualization dashboards are available in both the versatile cloud-based SaaS format or on-premises format with flexible customization.
- ▶ We provide an all-in-one service, from sensor selection, sensor procurement, until installation network construction, and providing the dashboard.

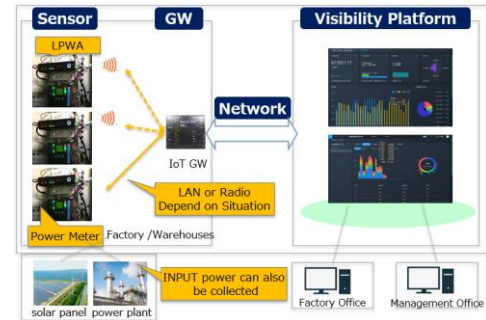

### Actual result and example

#### Electric visibility help to detect compressor air leak

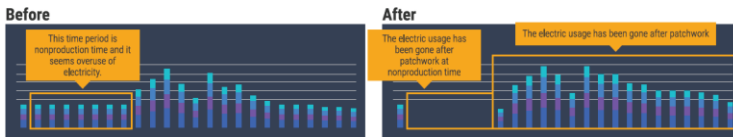

Analyzing power consumption of each equipment and time period. In the example above, 3% of power consumption was reduced by saving power.

#### Visualization of temperature and electricity power, and control refrigerator temperatures

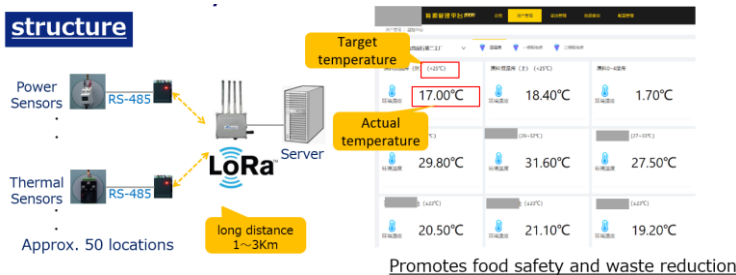

In a food factory, identifying inefficiency such as overcooling, and reducing electricity costs and carbon emissions by optimization of refrigerator temperature.

#### Select installation locations according to purpose

Generally, the process is conducted [overall consumption → each building → each line → each facility with high power consumption]

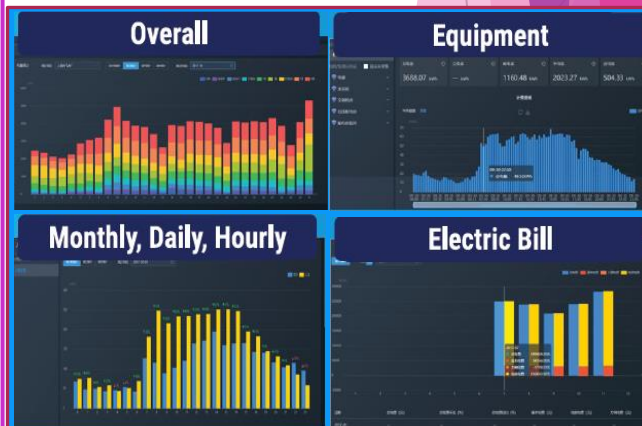
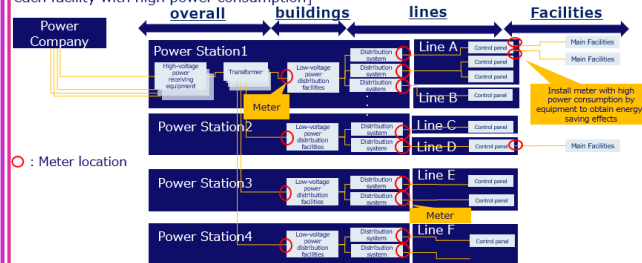

#### Contact point

PT. KDDI INDONESIA (English and Bahasa support)

—Phone number : +62-21-570-6303

—E-mail address : sales@kddi.co.id



# 7. Effective Use/Conservation of Resources

- **Waste Plastics and Waste Textile Recycling Technology**

(JGC HOLDINGS CO., LTD.)

- **LIMEX An Innovative New Material Made with Limestone**

(PT.SODANIKKA INDONESIA/TBM Co., Ltd.)

- **Eco-Friendly Plastics**

(PT CHORI INDONESIA)

- **Eco-friendly Asphalt Modifier 「NEWTLAC」 NEW**

(PT. Kao Indonesia Chemicals)

# Waste Plastics and Waste Textile Recycling Technology

- JGC Group's Chemical Recycling Technologies to Contribute to the Realization of a Recycling-Oriented Society-

## JGC HOLDINGS CO., LTD.

### Outline of Products and Services

- ▶ Recently, there is a need to establish effective solutions for global social issues such as marine pollution by waste plastics, proper disposal of waste, and reduction of GHG emissions. The JGC Group aims to realize a low-carbon society by providing chemical recycling technologies for waste plastics and waste fibers.
- ▶ The JGC Group has three chemical recycling technologies: waste fiber recycling, waste plastic oiling, and waste plastic gasification. Considering the degree of impurities contained in waste plastics, which are raw materials, product needs, economic efficiency, and CO<sub>2</sub> emissions, we propose optimal solutions that meet the needs of customers and society.

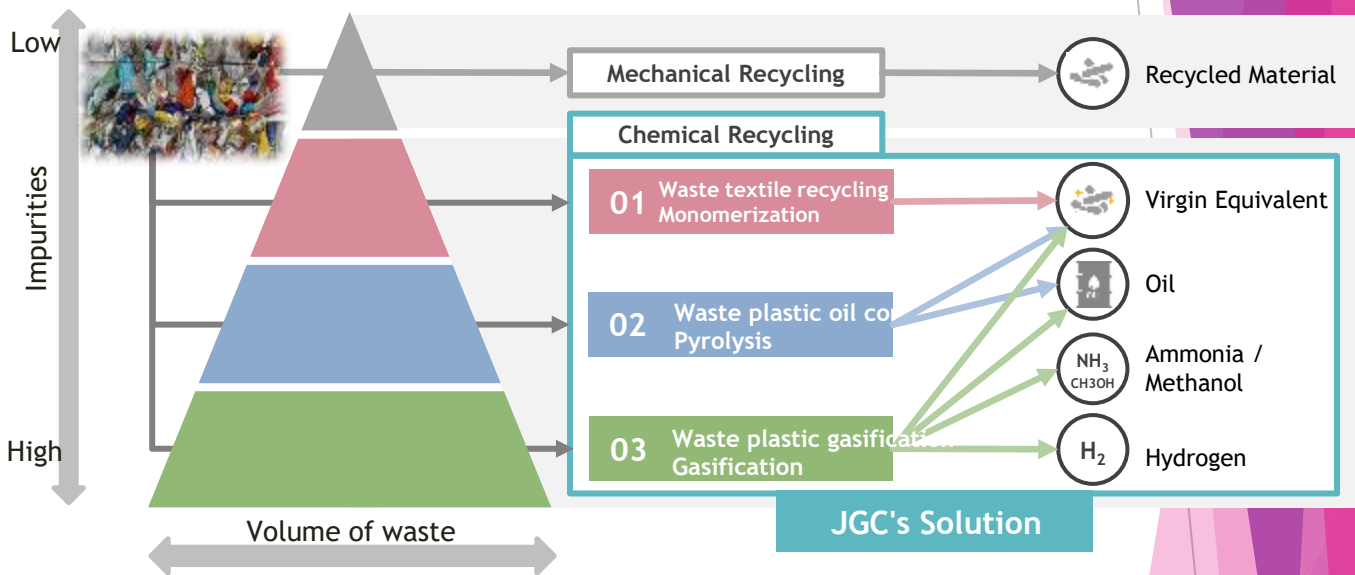

	Waste textile recycling Monomerization	Waste plastic oil conversion Pyrolysis	Waste plastic gasification Gasification
Characteristics	<ul style="list-style-type: none"> <li>✓ Textile-to-Textile Recycling</li> <li>✓ Excellent in eliminating dyestuffs and impurities compared to material recycling</li> </ul>	<ul style="list-style-type: none"> <li>✓ Process of obtaining heat decomposition oil derived from waste plastics</li> <li>✓ Waste plastics containing PVC and PET can be processed without separating them.</li> </ul>	<ul style="list-style-type: none"> <li>✓ Converted plastic containing mixed plastics and impurities into recycled products via synthetic gas</li> <li>✓ Contributing to the Manufacture of Local Production and Consumption Hydrogen</li> </ul>
Results and examples	<ul style="list-style-type: none"> <li>✓ Only technology with a proven track record of decolorization, impurities removal, and commercial operations</li> </ul>	<ul style="list-style-type: none"> <li>✓ 10-year commercial operation record</li> </ul>	<ul style="list-style-type: none"> <li>✓ Long-term commercial track record (only in gasification)</li> </ul>

### Contact Us:

JGC Holdings Corporation, Kenji Kawabata, +81-45-682-8333, [kawabata.kenji@jgc.com](mailto:kawabata.kenji@jgc.com)  
 PT JGC Indonesia, Toru Wagatsuma, +62-811-1920-6686, [wagatsuma.toru@jgc.com](mailto:wagatsuma.toru@jgc.com)

## Product and Service Outline

- ▶ LIMEX is an inorganic filler-dispersion composite material containing more than 50% inorganic materials such as calcium carbonate. LIMEX is developed, and manufactured by TBM Co., Ltd. with its patent in over 40 countries.
- ▶ LIMEX uses limestone as its main raw material. It can be molded into plastic and paper alternative products and can also be recycled.
- ▶ LIMEX Pellet can be processed into items such as packing material, containers, and daily products with existing molding machines, and LIMEX Sheet can be printed and bound with existing printers and binding machines.
- ▶ LIMEX Pellet can reduce plastic usage and greenhouse gas emissions compared to petroleum-based plastics, and LIMEX Sheet can reduce water consumption by approximately 97% compared to plain paper, and since it does not use any wood pulp, it can conserve natural resources at risk of depletion.
- ▶ LIMEX was introduced at international conferences such as COP and G20, and the technology has been registered with UNIDO's Sustainable Technology Promotion Platform "STePP".

## Actual Result and Example

More than 10,000 companies have adopted LIMEX.

- TBM Co., Ltd. and Indonesia's largest cosmetic container molding manufacturer, which handles products for major cosmetic manufacturers around the world, has concluded a sales agreement for LIMEX Pellet (injection molding grade only) for cosmetic containers. We are collaborating closely to deliver LIMEX cosmetic containers to the global market.
- Bio LIMEX Bag made of limestone and plant-based resin is used for shopping bags at stores in Haneda Airport.
- ※Bio LIMEX Bag is not biodegradable.
- LIMEX Sheet is used for the table menu of the Japanese branch of 添好運 (Tim Ho Wan), a Michelin-starred dim sum specialty restaurant in Hong Kong operated by WDI Co.
- LIMEX is used in a Gundam series plastic model and a dinosaur skeleton plastic model produced by BANDAI SPIRITS Co.
- LIMEX Sheet is used for the store displays of POLA INC. and the in-store illuminated menus of MOS BURGER.

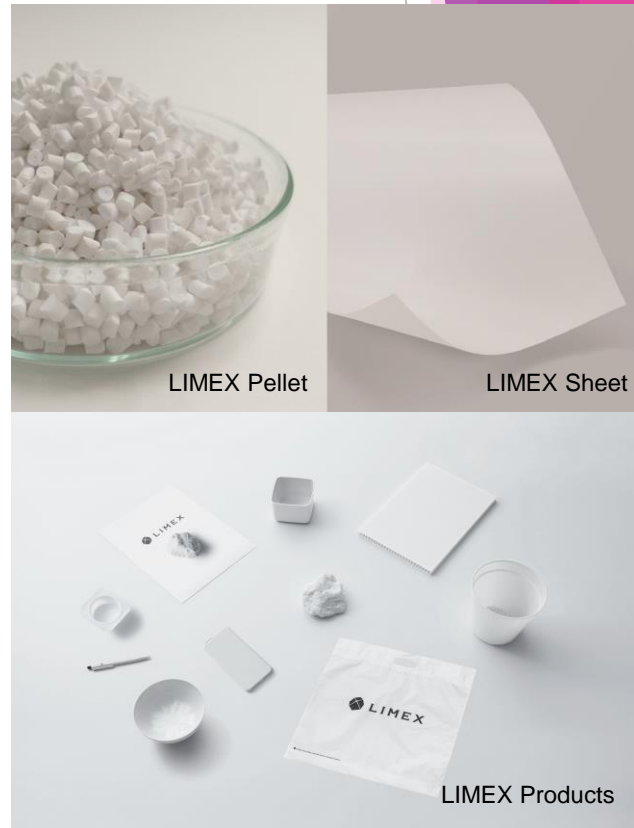

**Contact point: PT.SODANIKKA INDONESIA,SODANIKKA CO.,LTD, Jakarta Rep.**

Japanese、 English : Kentaro Shibahara :+62-813-8998-9215 : [k-shibahara@sodanikka.co.jp](mailto:k-shibahara@sodanikka.co.jp)

Japanese、 English、 Bahasa : Alex :+62-812-1359-9922 : [a-liga@sodanikka-jktrep.com](mailto:a-liga@sodanikka-jktrep.com)

English 、 Bahasa : Sodik :+62-813-1300-0800 : [nursodik@sodanikka.co.id](mailto:nursodik@sodanikka.co.id)

# Eco-Friendly Plastics

## -Bio-Degradable Resin for Film-

### PT CHORI INDONESIA

#### Product and service outline

- ▶ Biodegradable plastic can be used in the same way as ordinary plastic. It is an environmentally friendly product that is eventually decomposed into "water and carbon dioxide" by the activity of microorganisms. It is considered as one of the solutions to the plastic waste problem.
- ▶ PT CHORI INDONESIA can supply biodegradable/ocean-decomposable plastics such as PBAT, PBS, PLA(polylactic acid), and PPC. Also, We propose compound of these base materials and composite materials to supply a variety of compound resins. The compounds can improve price competitiveness and resin moldability.
- ▶ In order to contribute to solving the waste problem in Indonesia, we have started promoting biodegradable plastic resin.

#### About PT CHORI INDONESIA

- PT CHORI INDONESIA is the distributor specialized in textile and chemical and machinery, established in 1995 in Jakarta.
- Our parent company is CHORI Co.,Ltd. Japan. [蝶理株式会社 \(chori.co.jp\)](http://chori.co.jp)
- In our Chemical dept, we have been handling eco-friendly materials such a plant-based and less CO<sub>2</sub> emission etc.

#### Example of use of biodegradable resin



#### About Bio-Degradable Resin for Film

Product: Polybutylene Adipate Terephthalate(PBAT) Resin

Manufacturer : Huaфон Group Co.,Ltd. (CHINA)

Characteristic : Bio-degradable、Mass production、Technical Advantage

- PBAT Resin can be decomposed under composting conditions, meeting the requirements of US ASTM D6400, European EN 13432, Chinese GB/T 28206, and other biodegradable material standards, which make them good substitutes for traditional PE materials in film blowing, and injection molding field such as packaging materials, agricultural films, disposable tableware, etc. Huaфон has planned 11.8 billion yuan investment for the manufacturing of PBAT 300,000 ton and other bio-degradable plastic.

Application : Garbage bag / Shopper bag / Flexible Film / Air cushion / Mulch film

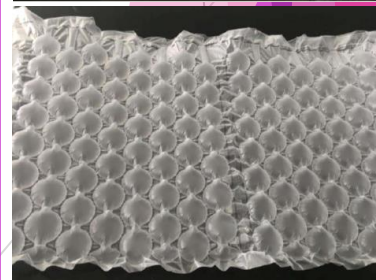

#### Contact Point

PT CHORI INDONESIA Chemical & Machinery Dept. (Authorized Agent in Indonesia)

—Phone Number— : +62-21-5723375

—E-mail Address— : [kupu-kupu.sales@chori.co.id](mailto:kupu-kupu.sales@chori.co.id)

(Mr. Kuwano & Yusuf : English/Indonesia/Japanese)



# Eco-friendly Asphalt Modifier 「NEWTLAC」

Next-generation road pavement that is friendly to the environment and people

## PT. Kao Indonesia Chemicals

### Product and service outline

- ▶ The Kao Group's corporate slogan is "Cleanliness in our hearts, in our future,". To achieve this goal, the Chemical Business Division promotes research and development that contributes to the construction of social infrastructure. In December 2020, we launched NEWTLAC, a modifier that uses waste PET as part of the raw material and improves durability by adding it to asphalt pavement. It is already being used for paving public roads, store parking lots, distribution centers, and factories.
- ▶ Rather than mixing waste PET as is, we use our proprietary technology to transform it into a new modifier.
- ▶ Increases the durability of added asphalt pavement by up to 3 times.
- ▶ By making asphalt pavement more durable, it is possible to reduce road surface damage and reduce CO2 emissions associated with repair work. It also helps provide safe and secure roads for users over a long period of time without incurring large costs.

### Actual result and example

(As of February 2024)

<Achievements in Japan>

- From 2020, full-scale rollout begins  
⇒ Over 90 records ; Retail store parking lots, highway parking areas, Logistics company bases, prefectural roads, city roads, etc.
- Japan Resilience Award, Resilience Award ; Received the semi-grand prize and gold prize (2022)
- Received the Minister of the Environment Award at the 50th Environmental Awards (2023)
- 22nd Green Sustainable Chemistry Award Received the Minister of the Environment Award (2023)

<Overseas expansion>

- United States, Thailand, Taiwan etc.
- Indonesia expansion 2022  
Confirmed the compatibility of NEWTLAC with Indonesian materials (asphalt and gravel) in an official evaluation organization
- Indonesia expansion 2023
  - Trial construction on our premises
  - Test construction on private land outside the company
  - Adopted in a private project

### Positive recycling : From waste PET to highly durable asphalt

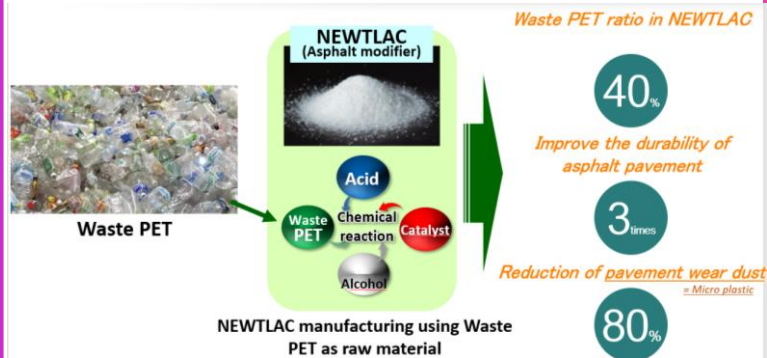

### Wheel tracking test in Indonesian public institutions (Using Indonesian asphalt raw materials)

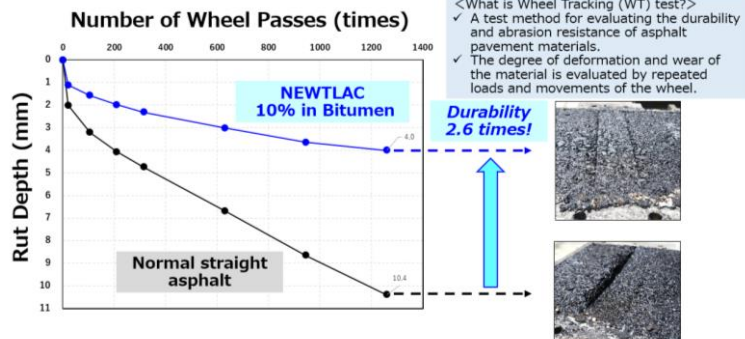

### Contact point

PT. Kao Indonesia Chemicals (Bambang : Japanese, English and Bahasa support)

—Phone number : +62-811-1085-198

—E-mail address : bambang@kaochem.co.id

# 8. Agriculture and Forestry Sector

- **Satellite data for soil analysis, fertilizer optimization and decarbonization of agricultural land**  
(Sagri (SATELLITE × AI × GRID))
- **One Stop Carbon Credit Solution Provider**  
(Green Carbon Inc.)
- **Mangrove Planting and Forest Conservation Project** **NEW**  
(YL Forest Co., Ltd. (PT. Yamamoto Asri ))

# Satellite data for soil analysis, fertilizer optimization and decarbonization of agricultural land

## Creation and sale of agriculture-derived carbon credits

### Sagri (SATELLITE × AI × GRID)

#### Product and service outline

Using satellite data analysis and the power of AI, we analyze the soil of farmland to reduce excessive use of chemical fertilizers, thereby creating and selling carbon credits which provide additional income for farmers.

- Farmland Compartmentalization by Machine Learning of Satellite Data (Patented)
- Soil analysis using satellite data, resulting in optimization of chemical fertilizer usage amounts
- Through optimization of fertilizer usage, we generate and sell carbon credits to the private sector.

The business model is to partner with agricultural companies, food companies, agri-tech companies, etc. which have a network of farmers to implement the project and share the profits from the creation of credits.

\* Companies interested in purchasing credits are also welcome to contact us.



#### Actual result and example

- Impact startup from Gifu University, founded in 2018, certified as a J-startup by METI Japan in 2023.
- Through our subsidiaries in Singapore and India, expanded business not only in Asia but also in Africa and Latin America and excellent in expanding business overseas.
- In Japan, trusted by central and local governments for public works projects, while in global business, conducting farming and carbon credit businesses.
- In India and Thailand, already reduced the use of chemical fertilizers in rice cultivation and has already completed the application for carbon credit projects.
- Has participated in many Japanese government projects in the past, such as JICA/JETRO/Ministry of Agriculture/METI projects ([examples on the JICA DX website](#)).
- Contact us if you are from agricultural companies, food companies, agri-tech companies, etc. which have networks with farmers, we are happy to cooperate with you.
- Contact us if your company is considering or intend to purchase credit carbon.

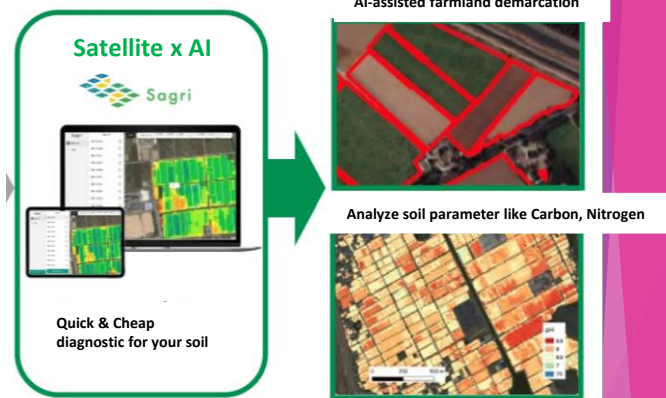

 Cheap and Quick Soil Analysis via Satellite

 Reduce Fertilizer (Data-based)

 Cost reduction/Less GHG emission

 Carbon Credit Generation

#### Contact point

**Sagri Singapore Branch Kazuki Sakamoto** (Japanese & English)

—Phone number : +65-8657-8375

—E-mail address : Sakamoto-kazuki@sagri.tokyo



LinkedIn  
(Kazuki)

# One Stop Carbon Credit Solution Provider

Through agriculture-based decarbonization projects,  
We reduce GHG emissions as well as increase Indonesian farmers' income

## Green Carbon Inc.

### Our Service Overview

- We develop carbon credit creation projects that are used to offset emissions for companies and local governments. We are involved in the entire process of carbon credit-related project formation, project registration, and the sale of the credits created.
- In particular, we focus on decarbonization activities (GHG reduction activities) using agriculture to combat global climate change and increase farmers' incomes through credit earnings. The project has a wide range of methods, some of which are shown on the right. The project areas are Southeast Asia (Indonesia, Philippines, Vietnam, Cambodia, etc.), Japan, Australia, and Latin America (Costa Rica).
- The types of credits are tailored to meet the needs of buyers, and can include JCM (Bilateral Credit Mechanism), VCS (Verified Carbon Standard), Gold Standard, as well as J-Credits, ACCUs, and other national schemes in each country.

### List of Agri-based Projects

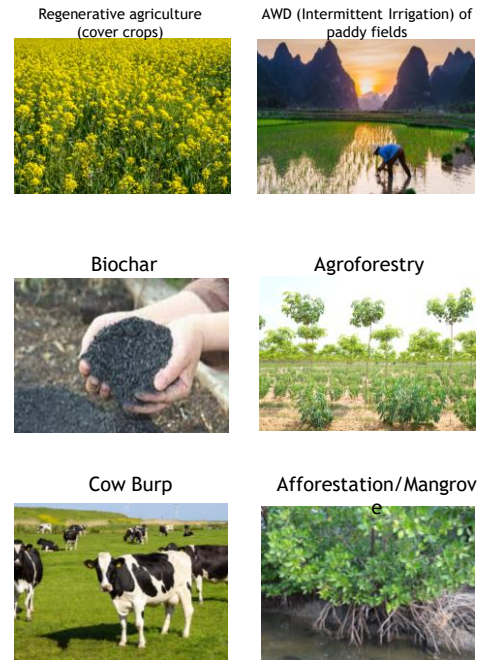

### Achievements and Case Studies

- With investment from companies committed to decarbonization, we will provide farmers with greenhouse gas reduction technologies and financing to form decarbonization projects and obtain carbon credits. Share revenue from sales of the carbon credits generated with farmers, thereby contributing to reducing global warming and increasing farmers' income

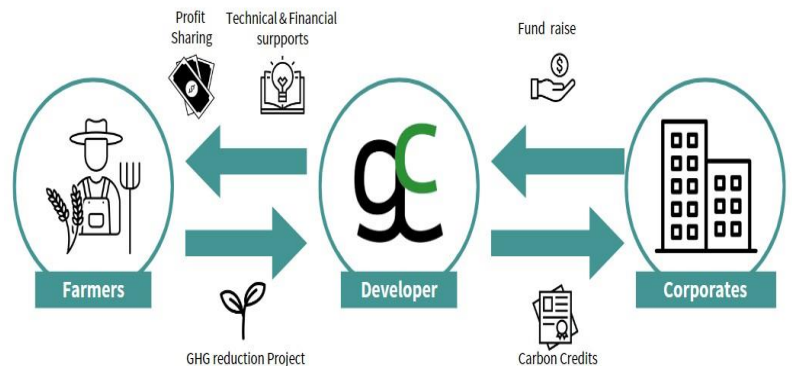

### PIC Contact

#### Green Carbon Inc.

★Takato Senoo (Mr.) : Japanese / English  
Tel : +63-917-892-9790

E-mail : [t.senoo@green-carbon.inc](mailto:t.senoo@green-carbon.inc)

★Haruki Yokoyama (Mr.) : Japanese

Tel : +81-80-7307-8836

E-mail : [h.yokoyama@green-carbon.inc](mailto:h.yokoyama@green-carbon.inc)



## YL Forest Co., Ltd. (PT. Yamamoto Asri)

## Product and service outline

In 2006, we established a local subsidiary in Batam City and started mangrove planting and forest conservation projects. We are developing 1) afforestation projects in tidal flats (new afforestation), 2) Silvofishery-type mangrove afforestation projects (forest regeneration), and 3) REDD+ projects (forest conservation). Additionally, as part of "Corporate Forest Development" project, we undertake the entire process from site selection to site negotiations, tree planting, and cultivation management for Silvofishery-type mangrove plantations.

## Overview of Silvofishery ("Corporate Forest Development" with Silvofishery)

Silvofishery is a system that combines "Silviculture" and "Fishery". Mangroves are planted on the site of aquaculture ponds or in aquaculture ponds where productivity has declined, and aquaculture is started in the surrounding area. Since aquaculture is cultivated in the mangrove ecosystem, it is possible to carry out aquaculture at low cost while preserving the natural environment without polluting the environment. It also leads to a stable livelihood for locals.

## Actual result and example

➤ **Mangrove plantations at Batam Botanical Garden and other places @ Batam City**

Since 2006, we have concluded MoU with the Batam government and developed new mangrove plantation project for 1,500 ha.

➤ **OKI-REDD+Project**

Since 2013, we have obtained Indonesia's first "Environmental Service Utilization Business Permit in Protected Forests" in the coastal area of Ogan Komering Ilir Regency in South Sumatra Province, and now in progress of afforestation and conservation mangroves in 23,500 ha. We aim to reduce and absorb 11 million tons of CO<sub>2</sub> over 30 years.

Joint developer: Mitsui O.S.K. Lines, Ltd.

➤ **Corporate Forest Development (Silvofishery)**

- Ricoh Bintan Forest
- Paramount Bed Mangrove Forest
- Honda Cars Saitama Kita Forest etc.

## "Silvofishery" image diagram

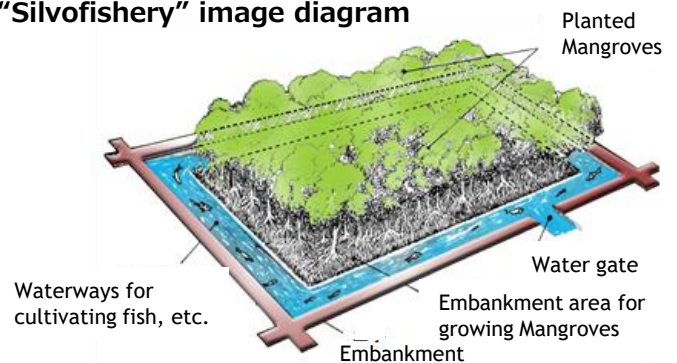

- **Measures against Global Warming:** Attract attention as blue carbon, and is known to have a high ability to accumulate carbon not only in trees but also in the soil.
- **Green Infrastructure (Eco-DRR,F-DRR):** Acts as a natural breakwater and seawall, contributing to disaster prevention resilience.
- **Ecosystem Conservation / Environmental Maintenance:** Mangroves form a unique ecosystem called the "cradle of life in the sea."
- **Realizing a Sustainable Society:** By coexisting and co-prospering with nature, we will achieve both sustainable forest management and aquaculture, contributing to the stability of local residents' lives.



## Contact point

YL Forest Co., Ltd.

—E-mail address : [info@ylforest.co.jp](mailto:info@ylforest.co.jp) (Japanese/English/Indonesian support)

Website : <https://ylforest.co.jp/>



## 9. Finance/Insurance etc.

- **Insurance Product Development et cetera**

(PT. Marsh Indonesia)

- **Leasing for Installing the Carbon Free Equipment**

(PT. Mitsubishi HC Capital and Finance Indonesia (MHCI))

- **Environmental Investment in Indonesia using JCM  
(Joint Crediting Mechanism)**

(Tokyo Century Corporation )

## PT. Marsh Indonesia

### Product and Service Outline

#### (Insurance broker business and insurance adviser business in renewable energy issues)

- ▶ As an insurance broker and adviser company, we are carrying out a lot of insurance broker business and insurance adviser business on the renewable energy issues (solar, wind power, hydropower, biomass, geothermal energy) in Indonesia.
- ▶ On the project financing issues, we are having an actual result as being a business owner's adviser and lender's adviser, carrying out insurance arrangement and insurance program with insurable and bankable condition.

#### (Industrialization support on the insurance side for hydrogen, ammonia multi-fuel combustion, CCS project)

- ▶ In this field, besides the case's composition, the insurance market dialogue is an important thing. Our company is grasping insurance market new trends and initiative plans through habitual communication with the insurance market, and all this information will be needed for industrialization. In addition to the insurance market undertaking condition, carrying out a case composition will be supporting the insurance and risk management point of view in the project.
- ▶ We are working on insurance product development toward an electric car and carbon neutral related product popularization and selling promotion.

#### (Creating ESG risk rating)

- ▶ Recently, insurance companies take charge of natural disaster risk are getting more interest in ESG, and customer company ESG initiatives are starting to bring an effect in insurance terms. Besides making dialogue with the insurance company, our company also performs a [visualization] of customers company ESG initiative, collecting the dialogue materials with the insurance market, and carrying out the insurance undertaking support.

### Actual Result and Example

- Insurance broker, insurance adviser's actual result (business owner's insurance adviser, lender's adviser) on the hydroelectric power generation, wind power generation, solar power generation, biomass power generation, geothermal electric power generation's case
- Carrying out a roadshow and explanation meeting to the insurance market about customers company's hydrogen, ammonia multi-fuel combustion, and CCS initiative
- Insurance product development and composition related to electric car
- Insurance product development and consideration of the product related to carbon neutral

### Contact Point

—Phone number—

+62 811 1330 6832 (Indonesia)

+81 80 3574 0783 (Japan)

—E-mail address—

[Shinnosuke.Izumi@marsh.com](mailto:Shinnosuke.Izumi@marsh.com) (Izumi)

—Location—

World Trade Centre 3, 16th Floor, Jl Jend Sudirman Kav 29-31, Jakarta 12920, Indonesia



**Insurance products to support a low carbon, sustainable economy**

# Leasing for installing the Carbon Free Equipment

~Leveling investment cost, Electricity cost reduction, Tax Benefit~

PT. Mitsubishi HC Capital and Finance Indonesia (MHCI)

## One of our Service Outline

- ▶ We established a new division, “Sustainability and Business Development Division” and leasing for solar panel, boiler, gas turbine, air conditioner and so on which can contribute to carbon reduction.

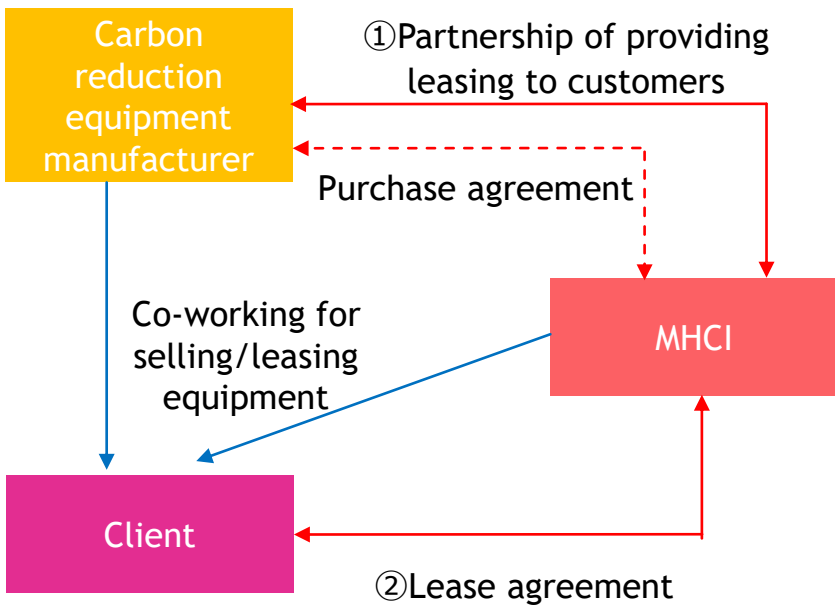

### 【①Partnership Agreement】

- ▶ Partnership agr. between manufacturer and MHC I. Co-work to offer the installation of equipment.

### 【②Lease Agreement】

- ▶ MHC I provides lease to customer

※MHC I also provides manufacturing equipment leasing, car leasing etc.

## 【Case example of Solar panel leasing】

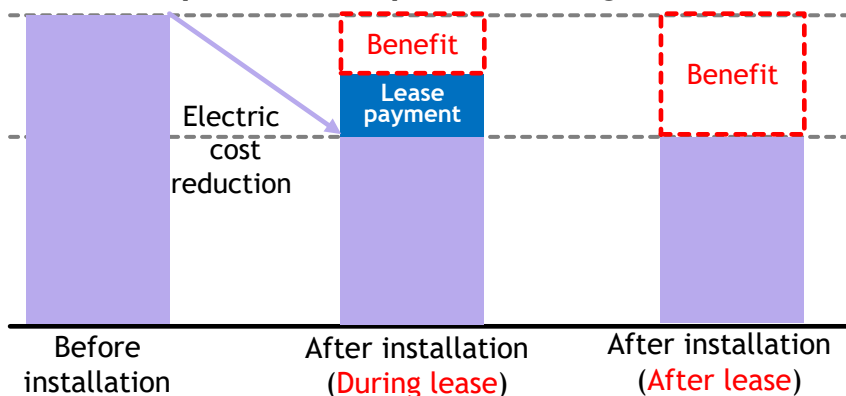

### <Benefit of leasing>

- ✓ Leveling investment cost
- ✓ Reduction of Electricity cost
- ✓ Tax benefit (Leasing payment is counted as COST for tax purposes)

(※) Above chart is just an image. Cost reduction may change depends on the condition and electricity cost fluctuation. MHC I does not guarantee the cost reduction.

## Contact point

- Kei Mitarai (Japanese/English)
- Tantonio Sujono (Indonesia/English)

[kei.mitarai@mitsubishi-hc-capital.co.jp](mailto:kei.mitarai@mitsubishi-hc-capital.co.jp)  
[tantonio.sujono@id.mitsubishi-hc-capital.com](mailto:tantonio.sujono@id.mitsubishi-hc-capital.com)



# Environmental Investment in Indonesia using JCM (Joint Crediting Mechanism)

## Tokyo Century Corporation

### Overview of Product/Service

- Japan implements JCM (Joint Crediting Mechanism) in order to contribute to the reduction and absorption of global GHG emissions, and to build a mechanism for technology transfer and countermeasures that can respond flexibly and promptly to the situation in developing countries.
- Among the JCM financial support programs, JCM Model Project will provide subsidy up to 50% of CAPEX, reducing investment cost.
- Tokyo Century is the first Japanese financial service company to Represent JCM, in developing businesses using decarbonization technologies in SEA countries.

### Project Example

- JCM Model Project (FY2017)  
Absorption Chiller installed at a Chemical Factory in Karawang West Jawa
- JCM Model Project (FY2018)  
High Efficiency Injection Molding Machine installed at Plastic Factory in Bekasi West Jawa
- JCM Model Project (FY2022)  
2.1MW Solar Power Plant installed at Aluminum Factory in Bogor West Jawa



(High Efficiency Injection Molding Machine)



(Solar Power Plant)

### Scheme

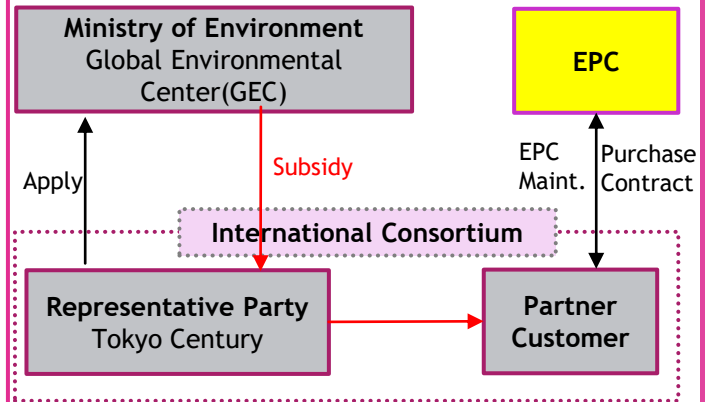

NES

(Absorption Chiller )

### Contact:

#### Tokyo Century Subsidiary in Indonesia

Tel : +81-5209-7438 (Mr.Ban, Mr.Kakumoto)

E-mail : [kakumoto.k@tokyocentury.co.jp](mailto:kakumoto.k@tokyocentury.co.jp)

# 10. Transportation

- **Rail Transport as an alternative to Truck Transportation**  
( PT YUSEN LOGISTICS INDONESIA)
- **“K” Line’s Activity to Transport Liquefied CO<sub>2</sub>**  
(Kawasaki Kisen Kaisha, Ltd. (“K” Line) )
- **Creating Carbon Credits in the Transportation Domain**  
(Spatial Pleasure Co., Ltd.)

# Rail Transport as an alternative to Truck Transportation

~ Why don't you consider it as one of the contributions to reducing CO<sub>2</sub> emissions ? ~

## PT YUSEN LOGISTICS INDONESIA

### Product and Service Outline

- ▶ Trucking is essential transportation for your business continuity. However, the general image of truck transportation in Indonesia is that there are many old vehicles, and it emit a lot of CO<sub>2</sub>.
- ▶ In order to respond the request **"we would like to consider decarbonization measures little by little because we can do it"**, Yusen Logistics is proposing rail transportation as an alternative to truck transportation in Java Island. We estimate that CO<sub>2</sub> emissions can be reduced by approximately 80% (by own calculation) when using rail transportation compared to truck transportation.
- ▶ Rail transportation can be used in a wide range of requirements, such as full container transportation loaded in factories/warehouses, less than container load (LCL) services, and domestic transportation or as a hub for international transportation.
- ▶ Please inform us what is your preference and consideration. On the other hand, we installed fast (battery) chargers in our company's facility outside Jakarta areas to facilitates trial operation for EV trucks.

< Rail Route Map >

< Loading on Rail for Full Container / Less than Container Load >

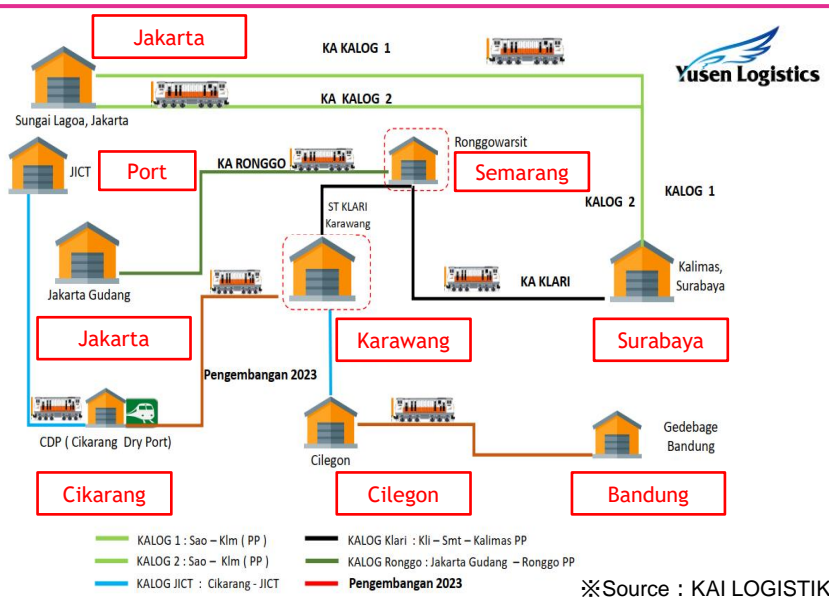

### Actual Result & Example

- Full Container : Loading cargo in Cikarang factory and deliver it by train from Cikarang to Surabaya. Then the container will be unloaded in Factory in Surabaya.
- Consolidation : Pick up cargo from Surabaya factory and deliver it by train from Surabaya to Jakarta, then continue the delivery process through Export Air Freight.
  - Pick up cargo from Semarang factory and deliver it by train from Semarang to Jakarta, then deliver it to factory in Tangerang.

Depend on the consultation subject, we also coordinate rail transport and pre- / post- rail transport arrangement.

Contact point  
PT Yusen logistics  
Indonesia

- ◆ Departure from Jakarta or Other Area  
Jakarta Head Office (ID/EN) : [YLID.ML.IFF.BD@id.yusen-logistics.com](mailto:YLID.ML.IFF.BD@id.yusen-logistics.com)
- ◆ Departure from Surabaya Area  
Surabaya Branch (ID/EN) : [YLID.ML.SUB.BD@id.yusen-logistics.com](mailto:YLID.ML.SUB.BD@id.yusen-logistics.com)
- ◆ For support in Japanese Language (JP) : [YLID.ML.JAPANESE.SALES.TA@id.yusen-logistics.com](mailto:YLID.ML.JAPANESE.SALES.TA@id.yusen-logistics.com)  
Contact Person : Mr. NAKAGAWA / 0811-1991-1729

# "K" Line's Activity to Transport Liquefied CO<sub>2</sub> Pioneer in marine transportation serving CCUS

## Kawasaki Kisen Kaisha, Ltd. ("K" Line)

### Product and Service Outline

- ▶ "K" Line is working to support the decarbonisation of our customers from perspective of a shipping company, as part of the "decarbonisation of society" to achieve net zero GHG emissions by 2050.
- ▶ One such solution is liquefied CO<sub>2</sub> (LCO<sub>2</sub>) transport, which contribute to customers' CCUS in the world. It shall become essential solution in Indonesia too because it is suitable for transportation between islands and remote areas.
- ▶ Based on years of experiences in LPG/LNG transportation, "K" Line as a pioneer in mass marine transport of CO<sub>2</sub> and is involved in CCS projects managed by leading world prominent of CO<sub>2</sub> emission and storage companies.

### Actual Result and Example

- **Participation in Northern Lights project**
  - "K" Line is participating in the world's first commercial CCS project supported by Norwegian Government. In 2024 "K" Line is planning to purchase and manage 2 unit of LCO<sub>2</sub> carriers.
  - The state-of-the-art vessels are equipped with variety of environmental-friendly equipment, LNG Engine, Rotor Sail utilizing wind power, a device that generates foam on bottom of vessel to improve drive performance, etc.
- **Demonstration of Low-Temp/Low-Pressure**
  - Temperature and pressure zones known as "Low-Temperature & Low-Pressure" (LTLP) is essential for the mass transport of LCO<sub>2</sub>.
  - "K" Line together with its partner in Japan, was entrusted by the government of Japan (NEDO) to be involved in operation of a technology demonstration vessel for LTLP transport start from the end of 2023.
- **Participation in CCS Projects worldwide.**
  - "K" Line was recognized of their track record in LPG/LNG transport and above activities as a pioneer in liquefied CO<sub>2</sub> transport. "K" Line is also taking part in joint study of CCS projects worldwide.
  - One of the published examples is the joint study with PETRONAS on CCS off Bintulu, Malaysia.
- **International Rule-making & Tech Development**
  - "K" Line is sending experts to SIGTTO and ISO working groups to lead/chair the international rule-making.
  - Taking part in a research related to the handling of liquefied CO<sub>2</sub> on ship, verify the collection of CO<sub>2</sub> on ship and also involve in joint study, etc. to handle cargo on ship as an initiative by Singapore MPA.



### Contact Point

#### PT. "K" Line (Indonesia)

TEL : +62-(0)21-521-4070 E-mail : wijaya.wira@id.kline.com  
(Mr. Wira Wijaya : English and Bahasa support)





# Creating Carbon Credits in the Transportation Domain

## Digital Measurement Reporting Verification Software

### Spatial Pleasure Co., Ltd.

#### Product and service outline

- ▶ Spatial Pleasure is developing DMRV (Digital, Measurement, Reporting, Verification) software to certify and measure carbon credits for transportation operators contributing to the decarbonization of an area.
- ▶ Through collaboration with bus and bicycle-sharing operators, our aim is to decarbonize the entire region by quantifying the environmental benefits of each transportation operator and issuing carbon credits.

#### Actual result and example

- Spatial Pleasure has agreed to conclude a partnership with Sinar Mas Land, part of the major conglomerate Sinar Mas Group, and its corporate venture capital firm, Living Lab Ventures, to promote decarbonization in urban transportation domain in Indonesia.
- The above-mentioned initiative was supported by JETRO (Japan External Trade Organization), aiming at promoting decarbonization of urban transportation, with BSD City at its center.
- BSD City is one of Indonesia's largest urban development projects, with approximately 400,000 people living on an approximately 6,000 hectare site. As the operating company of BSD City, Sinar Mas Land has been actively promoting measures to reduce transportation-related carbon dioxide emissions. These efforts include a variety of projects such as shuttle bus networks and sidewalk improvements.



### Data platform for Decarbonizing the transportation sector in City.

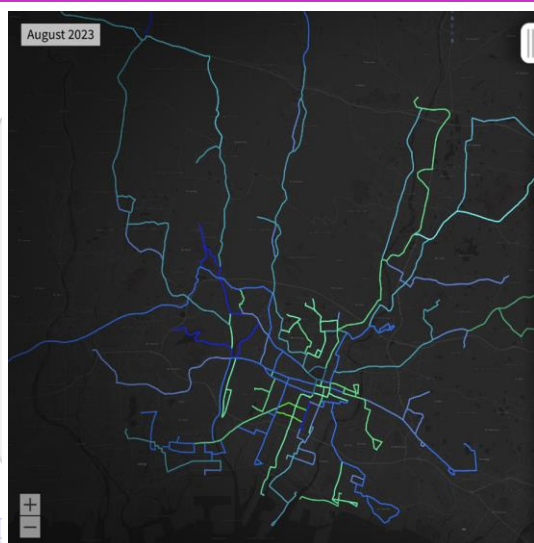

#### Contact point

Spatial Pleasure Co., Ltd. (Mr. Soma Suzuki, CEO)

–Phone number : +81-80-9530-4903

–E-mail address : soma@spatial-pleasure.xyz

# 11. Strategy formulation and consulting for decarbonization

- **Strategic Consulting for Decarbonization**

(Qunie Corporation )

- **CMP WAY**

(CM PLUS GROUP CORPORATION)

- **GX Management Cycle Actualization Service**

(ABeam Consulting Ltd.)

- **Decarbonization Solution Advisory Services**

(Enel X Advisory Services Japan G.K.)

- **Building Trust with Sustainability**

(PwC Indonesia)

# Strategic Consulting for Decarbonization

From Strategy Formulation to Implementation in High-tech, Electricity and energy, and Mobility

## Qunie Corporation

### Product and Service Outline

- ▶ Qunie Corp. is a consulting company in the NTT DATA Group, providing consulting services in Japan and globally, from management strategy formulation to implementation to achieve corp. innovation.
- ▶ In the decarbonization area, our GSB team offers consulting to assist Japanese corps in establishing new businesses and management strategies in Japan and abroad in high-tech, electricity and energy, and mobility areas. We can also provide support in collaboration with our other teams and NTT DATA.

#### (GSB Team) Decarbonization Consulting Service

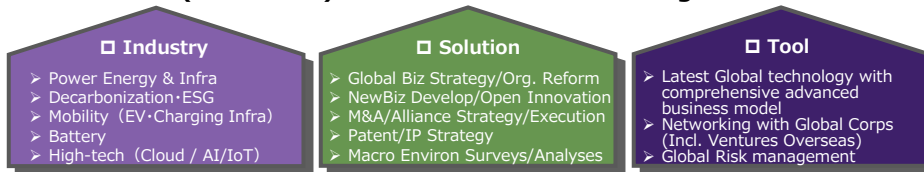

### GSB team Service line

- Support covers from Macro-environmental understanding and Strategy formulation to Implementation in global perspectives.

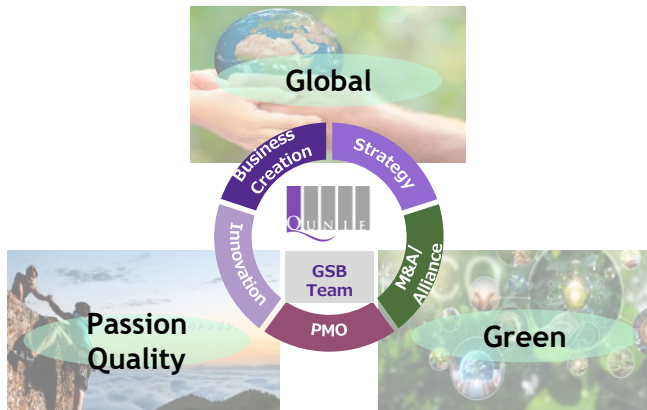

#### About GSB Team

- The GSB team specializes in global consulting projects. The team consists of members who are fluent in a third languages other than Japanese or English, as well as from major global companies and consulting firms, and is capable of handling various global projects.

### Actual result·Example

#### ▪ Global Decarbonization Strategy Development Support

Support for building a global organization consisting of the client's Japan HQ and global offices to establish a global decarbonization strategy, and conduct marketing research and client capability research in APAC related to decarbonization and sustainability.

#### • Basic research on LCA methodology

Research on LCA-related policies and rules, calculation methods, and case studies of advanced companies in Europe, China, which is a major EV country, and California, where strict environmental regulations are in progress.

#### • Decarbonization Business Discovery &Market Research

Research on the latest decarbonization-macro environment, identifying use cases and techs of European and US firms in non-energy areas (food, etc.), and examining main solution based on the results of the research.

#### • VPP Build via Portable Batteries

Support to develop and verify a new business model for VPP that links power generators using portable batteries and electricity users such as firms and households in Japan.

### Contact Point

—Phone Number—

+62 811 1077 870 (Hironori Matsubara(Mr.))

+81 80 8455 4980 (Tomoya Sakai(Mr.) : English Support)

—E-mail Address— : [sakait@qunie.com](mailto:sakait@qunie.com) (Tomoya Sakai(Mr.) : English Support)

# CMP WAY

Comprehensive Energy Solution for operational plant



## CM PLUS GROUP CORPORATION

### Product and service outline

- ▶ Engineering
  - ▶ GMP Consulting
  - ▶ Matching
  - ▶ Training Support
- Energy Solution**

**CMP Way**<sup>®</sup>

*CMP is the unique professional Engineering/ Consulting service company with project management Skill. For the solutions of carbon neutral, CMP provides the clients with services such as **FS with gap analysis, solution implementation management and advisory services**. We call it as 'CMP Way'.*

- ✓ Process oriented Energy Reduction
- ✓ Utility oriented Energy reduction
- ✓ Continuous Optimization

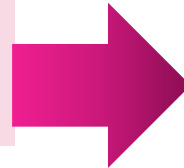

**Comprehensive Energy Solution**

### Stages: 1 Feasibility Study

To Propose Comprehensive energy saving solutions and road map to achieve the target from the GAP analysis from the viewpoint of production side and facility utility side

### Stages: 2 Solution Implementation

To perform engineering such as Conceptual Design and Request for Quotation for the various solutions to achieve the CARBON NEUTRAL reduction

### Stages: 3 Advisory Stage

To monitor the achievement of target baseline/Roadmap and make advise for the continuous further improvement

**Procedure → Initial Gap analysis (walkthrough) is FREE**

**Implementation menu with Items:**  
Productivity Improvement, Energy Saving & ROI

*"CMP is free from Vendors, free from contractors. We work for the clients only."*

With CMP ways method, the client will get not only the right person/company which are suitable to execute the project but also the client will get a PLUS on how to improve the existing production process with provision of the future planning, in others word, the client will get double benefit, improvement and efficiency.

*Please contact us if you have any questions or concerns about your facility construction project.*

**Contact point : PT. CM Plus Consulting Indonesia**

(Mr. Shandy : English and Bahasa support)

— Phone number : +62-811-1358-088

— E-mail address: [shandy@cm-plus.com](mailto:shandy@cm-plus.com)

- <https://cm-plus.com/>
- <https://cm-plus.co.jp/>
- <https://www.cm-plus.co.id/>



# GX Management Cycle Actualization Service

**ABeam Consulting Ltd.**

## Product and Service Overview

We provide one-stop support that includes not only the development of long-term GX strategy and a GHG reduction roadmap, but also the following services to help actualize a GX management cycle for evaluating and revising plans.

- ▶ **GHG status discovery service**  
Determining the data to be collected and its extent within each Scope / Calculating GHG emissions and performing theoretical verification
- ▶ **GX Strategy and Policy Development Service**  
Climate change-related information disclosure (TCFD, financial reporting), goal setting, selection of priority measures, evaluation of implementation effectiveness and development of roadmap and action plan (long and short term).
- ▶ **GX Solution Implementation Service**  
Introduction of various GX solutions for reduction and offset (renewable energy, certification, credits, EV, energy saving, new energy, CCUS, etc.)
- ▶ **GHG Emissions Management Cloud Service**  
GHG emissions management cloud services that include your company and supply chain

## Results and Case Studies

### The Case of a Food Manufacturing Company

- GHG status quo: Calculated over 2 months
- GX strategy and policy development: Strategy development and priority setting over 3 months
- GX solution implementation: Parallel implementation of multiple measures such as PV, credits, etc.
- GHG emissions management cloud service: implemented over 3 months

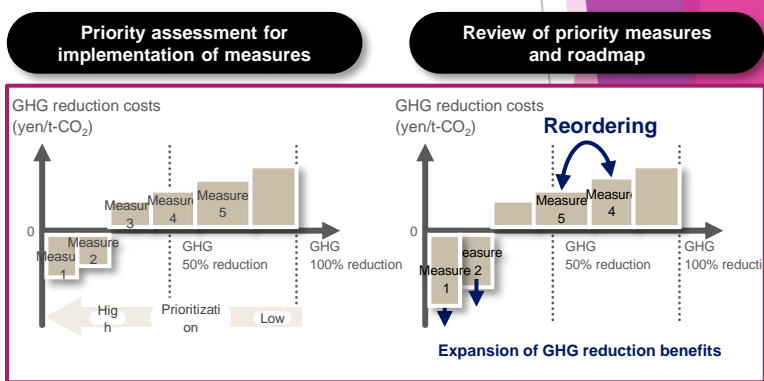
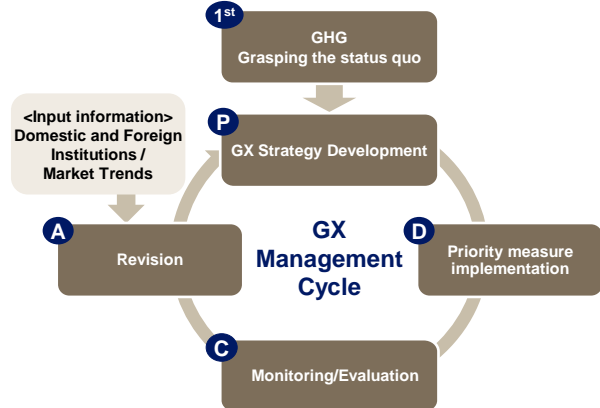

### Scope 1,2 Reduction Roadmap

	202x~	2030~	2040~	2050
Measure 1	Plan, Implementation, Operation			
Measure 2		Plan, Implementation, Operation		
Measure 3			Plan, Implementation, Operation	

## Contact Point

**PT. ABeam Consulting Indonesia**



Phone: +62-21-526-8660 (available in English & Bahasa Indonesia)

E-mail address: [idabglobalgx\\_iddl@abeam.com](mailto:idabglobalgx_iddl@abeam.com) (Available in Japanese, English & Bahasa Indonesian) **80**

# Decarbonization Solution Advisory Services

## Renewable Supply/ EACs/ Calculation on GHG emission etc.

Enel X Advisory Services Japan G.K.



### Service outline

- ▶ Support for procurement of renewable energy (Virtual) PPA Advisory
- ▶ Support for calculation of Scope 1, 2, and 3 based on global standards
- ▶ Support for roadmap development, including mid/long-term energy strategies
- ▶ Global centralized procurement of environment certificate etc.



enel x Advisory Services  
Global One Stop  
Support Services

For Global Companies

EU

APAC

US

### Service Features and Track Records

- ▶ A consulting arm of Enel group, a leading energy company in the world
- ▶ Support for global/local clients to achieve their decarbonization goals
- ▶ Market intelligence and energy market research for global/local clients
- ▶ Global and local support from over 400 advisors in 28 countries



Visualization of  
Energy Consumption

Utility Data Management

- Calculation on GHG
- Scope 1,2,3 emission
- GHG emission reduction
- RE100/CDP<sup>1</sup> report
- Decarbonization roadmap strategy



Optimizing energy  
procurement

Energy Procurement

- Energy Optimization
- Market risk assessment
- Risk management on energy procurement
- Energy procurement through Auction



Optimization of  
energy efficiency

Energy Efficiency

- Real time monitoring energy consumption
- Algorithm analyse
- Energy cost reduction



Renewable energy  
procurement

Advisory –  
Renewable Supply

- Procurement on EACs
- On-site PPA
- Off-site PPA
- Sustainability strategy

Tailor-made advisory for each country/ region available upon request

enel x

Contact:

TEL: +81-3-6774-7180

E-mail: enelxad-jp.enelx@enel.com

English/Japanese

➤ Ms. Yuko Yamasaki

English/Bahasa

➤ Ms. Udyani Putu

# Building Trust with Sustainability

## Comprehensive Services for Energy Transition and Decarbonization

### Product and service outline

#### ESG Strategy & Sustainable Supply Chain Roadmap

- ESG strategy & roadmap, Supply chain decarbonisation roadmap, ESG transformation, including people, process and system

#### Carbon Market Advisory

- Assistance on carbon project registration for local and international market, carbon credit evaluation, carbon credit project feasibility study, domestic and international carbon trading advisory, legal due diligence against the potential forestry concession area, and relevant accounting and tax advice for carbon trading etc.

#### Decarbonization Business Development

- Market analysis, feasibility study, business structuring and strategy development, regulatory advice, cash-flow modeling, and relevant accounting and tax advice on Renewable Energy, Bioenergy, Energy Efficiency, Energy Management, Smart Energy, EV & E-bike, Storage Battery, CCS/CCUS, Direct Air Capture, Hydrogen, Ammonia etc. related business development and implementation.

#### Sustainable Finance

- Green taxonomy mapping, climate stress testing, climate risk management, sustainable finance framework.

#### Sustainability Reporting

- Gap analysis on the current report against international standards/frameworks (including GRI Standards and IFRS S1 and S2), materiality assessment, Sustainability Reporting development assistance, Sustainability Reporting Assurance, climate risk and scenario analysis, GHG accounting and assurance, ESG Rating readiness & improvement and Internal Audit for improving internal process and control in the Sustainability-related areas etc.

### Details of Indonesia carbon market advisory

PwC Indonesia offers professional services in a variety of phases for carbon market entry.

#### ① Technical Study

- Measurement of actual emission baseline and results of emission reduction efforts, potential carbon stock and sequestration, carbon offset, and other carbon-related calculations

#### ② Legal Study

- Identification of relevant regulations on Indonesian Carbon Market scheme and assistance on the related legal structure of the carbon project and implementation for local and international businesses to participate in the carbon market

#### ③ Economical Study

- Carbon credit potential analysis which include potential cash inflow from carbon sequestration of carbon projects and carbon accounting services

#### ④ DRAM and SRN PPI Registration

- Assistance in preparing DRAM (Design document of climate change mitigation action) and navigating SRN PPI(National registry system for climate change) registration and procedures

#### ⑤ Intermediary Analysis

- Advisory on carbon exchange administrator and intermediary services to participate in the carbon market

### Carbon market entry (Voluntary market)

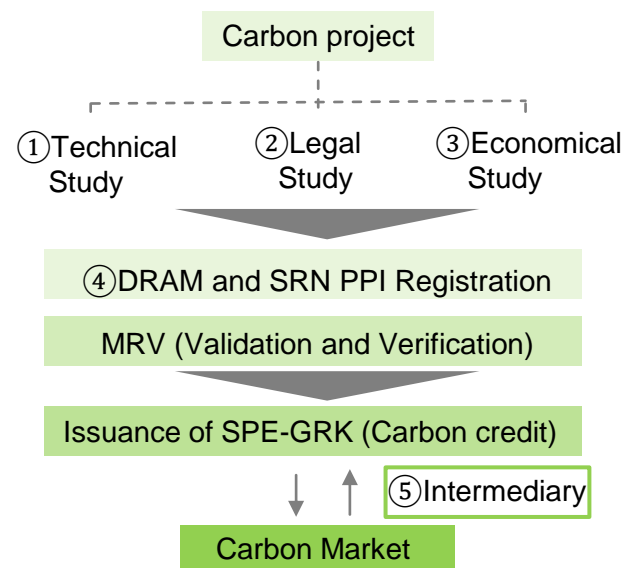

### Contact point

PwC Indonesia Japan Business Desk, Advisor (ESG), Kotaro Asai (Japanese and English only)

—Phone number : +62-813-1861-1912

—E-mail address : kotaro.asai@pwc.com

# 12. Comprehensive Solution to Decarbonization

- **Asset Optimization for NZE**  
(PT. Mitsubishi Power Indonesia)
- **JGC's Total Engineering for Renewable Energy**  
(JGC Holdings Corporation )
- **Housing and Community Decarbonization**  
(PT. Sumitomo Forestry Indonesia)



# Asset Optimization for NZE

Asset Evaluation, Technology Introduction with simulation by Energy market Modeling

## PT. Mitsubishi Power Indonesia

### Product and Service Outline

- Countries are required to economically optimize the introduction of renewable energy and the stability of the power system while achieving carbon neutrality targets.
- MHI uses an analytical model of the electricity and energy markets to provide businesses and related organizations with asset evaluation and technology implementation optimization services that address the balance between decarbonization and economic efficiency.
- Based on its broad range of products and technical expertise related to Energy Transition, and the results of analysis conducted in various countries around the world, MHI propose an asset optimization policy for our customers.

#### MHI Market Model

##### Case Assumptions

- Decarbonize Target
- Demand, Fuel Price, VRE Introduction

##### Asset database

- Transmission Line
- Generation Asset (Location, Spec, Cost))

#### Interconnected Model 150~500kV



#### Operation Pattern Forecast / Upgrade Proposal

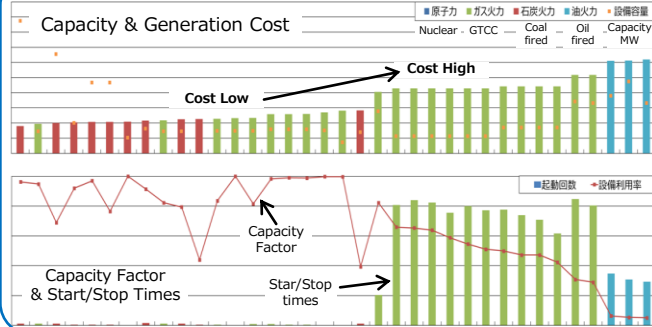

## Experience and Example

### 1. Strategy to utilize existing asset

Expect the future utilization of facilities and propose measures to improve profit by modifying it using the best suitable technology for the business environment in future.



Efficiency of each power plant  
(Cost reduction xCO<sub>2</sub> reduction)

Improving operational efficiency across the grid

Flexibility, Improvement, For, Renovation  
Example: gas-fired power generation

- Minimum load (the minimum amount of standby power that must be maintained)
- ramp rate (speed of power up/down)

Driving (Income) Change  
Energy market ↑  
Regulatory capacity market ↓  
Total ↑

Renewable by renovating generators  
Reduce energy control

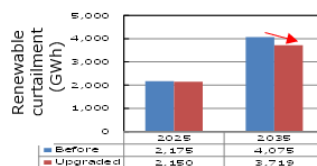

✓ Minimize reduction of renewable energy generation

renewable energy  
Maximum use of CO<sub>2</sub> and emission reduction

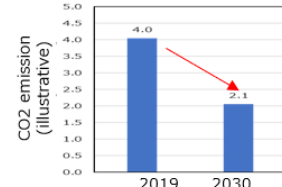

✓ Use of renewable energy regardless of grid constraints

### 2. Future Asset portfolio with decarbonatization

By showing the most economical power supply configuration in the future, we will propose the necessary technology and schedule capital investment, quantify the impact of the business environment, such as change in power demand, and policy options, such as the CO<sub>2</sub> target and use it to assess risks and provide data for policy discussions. MHI has been conducting a joint study with the Bandung Institute of Technology about the decarbonization strategy in Indonesia to propose several suggestions to make it economical and practical.

### 3. Optimizing facility specification for decarbonatization project

For hydrogen or ammonia project for production or storage, the economy should be estimated based on future generation patterns, equipment specifications, and collection prices. Based on case studies of equipment specifications, MHI propose an optimal equipment configuration based on the fluctuation of prerequisites.

## Contact Person

—Phone number— +62-(0)21-8066-8900

—E-mail address— [kazuhiro.yoshida.2p@mhi.com](mailto:kazuhiro.yoshida.2p@mhi.com) (Japanese/English), [rully.bakrie.tr@mhi.com](mailto:rully.bakrie.tr@mhi.com) (Japanese/English/Indonesian)

# JGC's Total Engineering for Renewable Energy (Solar, Geothermal, Hydrogen, Ammonia, Biomass, Wind, etc.)

## JGC Holdings Corporation (PT. JGC Indonesia)

### Product and service outline

- ▶ As a world-class Engineering contractor, JGC has delivered various plants and facilities globally, supporting client endeavors. Our robust track record spans 20,000+ projects across 80+ countries, earning us recognition for top-tier performance.
- ▶ JGC has long prioritized renewable energy, pioneering solar power in Japan since 2012. With a strong domestic solar power record and projects in Indonesia, Vietnam, Mongolia, and beyond, we're committed to fostering a low-carbon society. This includes expanding into energy transition, carbon management, and sectors like solar, geothermal, biomass, wind, hydrogen, and ammonia.
- ▶ With 1,000+ staff in Indonesia and 2,600+ in Asia, we focus on local projects for competitive pricing, agility, and quality. Our services, from Feasibility Studies to EPC, ensure optimal infrastructure regardless of project size.

### Actual result and example

- Geothermal Power Generation (Binary Type) 28MW
- Geothermal Power Generation (Binary Type) 5.6MW
- Solar Power Generation 69MW
- Solar Power Generation 68.8MW
- Solar Power Generation 49MW
- Solar Power Generation 5MW + Battery Storage 3.6MWh
- Roof-Mounted Solar Power Generation Totaling 15MW
- Roof-Mounted Solar Power Generation 2MW
- Roof-Mounted Solar Power Generation 3.35MW
- Roof-Mounted Solar Power Generation 0.2MW
- Roof-Mounted Solar Power Generation 0.2MW
- Roof-Mounted Solar Power Generation 1.1MW
- Biomass Power Generation 75MW
- Biomass Power Generation 75MW
- Others



Geothermal



Geothermal



Solar + BESS



Rooftop Solar



Hydrogen/Ammonia



Biomass Power

### Contact point

PT JGC Indonesia

Toru Wagatsuma | +62-811-1920-6686 | [wagatsuma.toru@jgc.com](mailto:wagatsuma.toru@jgc.com)



# Housing and Community Decarbonization

## Providing highly efficient, EDGE-certified decarbonized housing

### PT. Sumitomo Forestry Indonesia

#### Business Outline

- ▶ The Indonesian government has announced the goal to achieve Net-Zero Emissions or “carbon neutral” by 2060. In the housing and real estate industry, decarbonization has also become an important topic.
- ▶ By utilizing low-carbon building materials as well as promoting ZEH (Zero Energy Housing) and ZEB (Zero Energy Building), our company is working to reduce CO<sub>2</sub> emission during a building’s construction process and when a building is being occupied, and not only in Indonesia but also in other countries around the world. In 2022, we have opened our first LCCM (Live Cycle Carbon Minus) model house in Japan. \*LCCM houses are homes that results in negative CO<sub>2</sub> emissions through minimizing CO<sub>2</sub> emissions in each stage of the house’s life cycle, from construction, occupancy to demolition, as well as creating renewable energy such as solar power generated electricity.
- ▶ As an effort to make CO<sub>2</sub> emissions during construction and occupancy more visible, we are currently in the process of obtaining EDGE certification which is promoted by IFC. Increasing the overall efficiency of a house will also benefit our customers through electricity and water saving. Our future projects in Indonesia will also incorporate environmental certification such as EDGE, and we will lead the decarbonization of housing in Indonesia. Our goal is not only to minimize CO<sub>2</sub> emission in residential, but also the community and society as a whole.



**International Finance Corporation**  
WORLD BANK GROUP

Creating Markets, Creating Opportunities

EDGE is a building environmental assessment system. EDGE certification is awarded to buildings that are able to save 20% or more on energy usage, water usage and embodied energy, compared to a typical building. Meanwhile, EDGE Advanced certification is awarded to buildings that are able to save 40% or more energy.

#### Portfolio and Future Projects

Morizen Cluster in Bekasi, West Java

Project	1	2	3	4
Location	Bekasi	Makassar	Depok	Bogor
Progress	Handed over	Launch on Feb 2024	Launch on Nov 2023	Launch on Aug 2024
Area	5 ha	14 ha	6 ha	3 ha
Units	157	508	350	150
EDGE	N/A	Standard	Advanced	Under assessment
Decarbonization	Energy-saving design, LED, water-saving	Energy-saving design, LED, water-saving	Energy-saving design, LED, water-saving, smart home, solar panel, AAC	Energy-saving design, LED lights, water-saving



Energy-saving design (natural circulation & shade from sunlight)

Solar panel (energy creation)

Water-saving appliance & LED light

AAC Blocks (replacing burned red bricks)

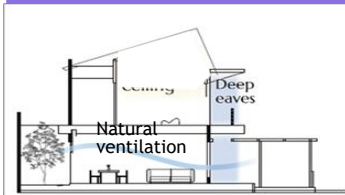

#### Contact point

**PT. Sumitomo Forestry Indonesia** (Ms. Sherlina Evangela: English and Bahasa support)

— Phone number : (+62)-21-520-0268

— E-mail address : sherlina@sf-Indonesia.com



# Map of Decarbonization Efforts by Japanese Companies

Jakarta Japan Club (JJC) and JETRO Jakarta publish decarbonization projects carried out by Japanese companies. It is estimated that Japanese effort reduces 30 million tons carbon dioxide in Indonesia in 2022.



## Map of Decarbonization Efforts by Japanese Companies (January 2024)



- Effort towards decarbonization: **623 projects by 258 Japanese companies**
- Carbon reduction effort by Japanese companies: **30 million tons/year**

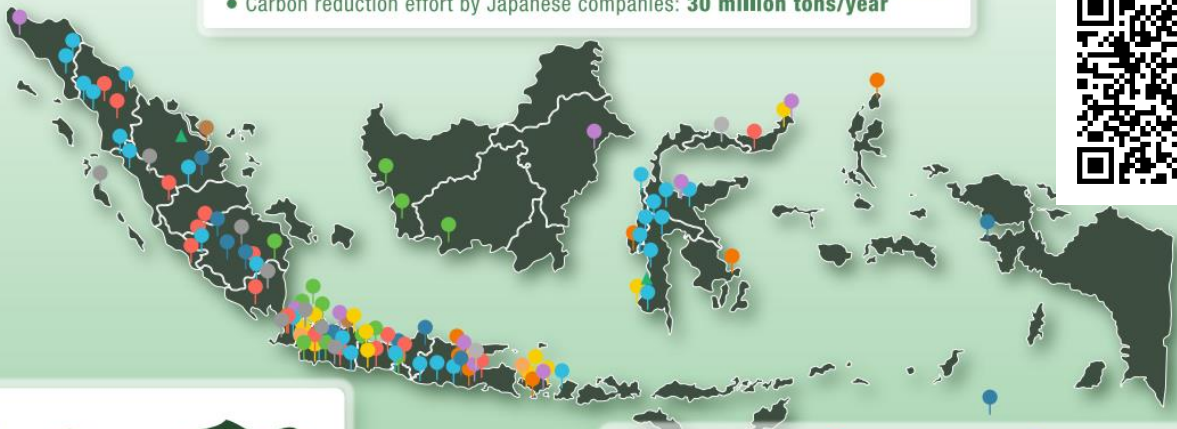

Note: There are many more contribution efforts by Japanese companies that are not stated above, such as effective use of resource, decarbonization of shipping and aviation sector, and purchase of Renewable Electricity Certificates (RECs)

- Solar Power Plant (Running)
- Solar Power Plant (Considering)
- Hydropower Plant
- Geothermal Plant
- Ammonia/hydrogen
- Carbon Capture, Utilization & Storage (CCUS)
- Vehicle Electrification & Battery Storage
- Fossil Fuel Decarbonization
- Forest Sector
- Biomass
- Other

## Carbon Emission Reduction by Japanese Companies in Indonesia (Projected amount by various sectors)

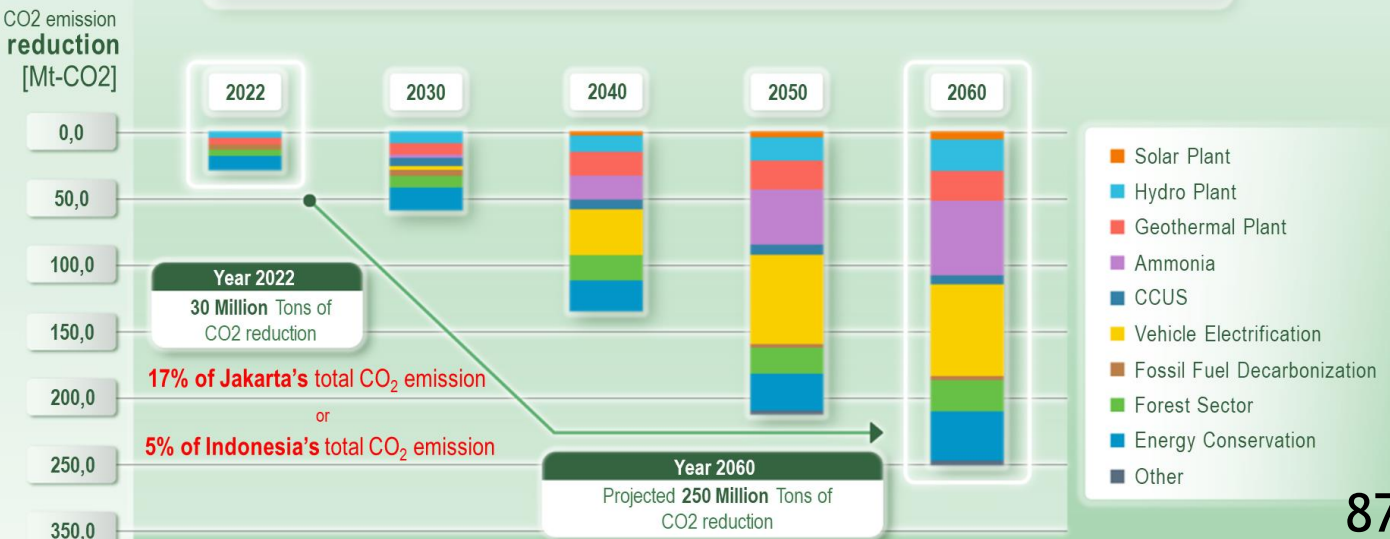



This business catalog is published on the website of the Japan External Trade Organization (JETRO) Jakarta Office.



Japanese



English



Indonesian

***Talk to JETRO first!***

## **JETRO Jakarta Office**

Summitmas I, 6<sup>th</sup> Floor, Jl. Jend Sudirman Kav. 61-62, Jakarta 12190 Indonesia



**(Inquiries regarding this document)**

MATSUDA Akihisa

Vice President Director,

Japan External Trade Organization(JETRO), Jakarta Office

E-mail [Akihisa\\_Matsuda@jetro.go.jp](mailto:Akihisa_Matsuda@jetro.go.jp)

TEL +62-811-912-766

