



JETRO PAVILION
Estimate Drawing for Construction Proposal



Date: November 20-23, 2019
Venue: Bangkok International Trade & Exhibition Centre (BITEC)

BIGBEAT INC.

Exhibition Hall Map

NO. 1 MACHINE TOOLS & METALWORKING EXHIBITION SERVING ASEAN – 33rd EDITION 2019



Venue

Bangkok International Trade & Exhibition Centre (BITEC)

Address

88 Bangna-Trad Road (Km.1), Bangna, Bangkok 10260, Thailand

Exhibition Dates

November 20-23, 2019

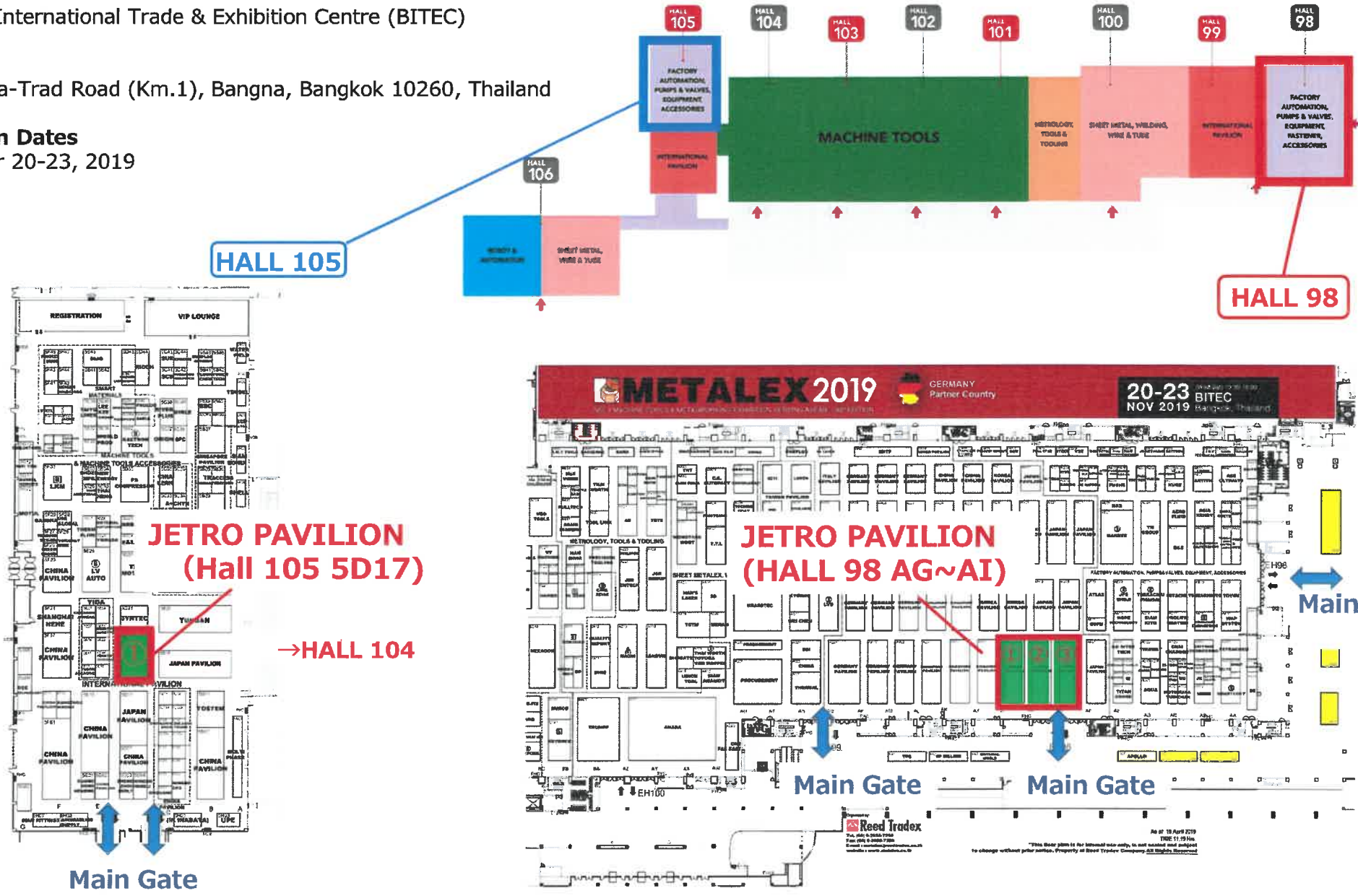

**JETRO PAVILION
(Hall 105 5D17)**

→ HALL 104

**JETRO PAVILION
(HALL 98 AG~AI)**

Main Gate

Main Gate

Main Gate

Reed Tradex

AG of 18 April 2019
TREC 1919
This floor plan is for internal use only, to not scaled and subject to change without prior notice. Property of Reed Tradex Company. All Rights Reserved.

In-Hall Working Zone

■ HALL 98 (ZONE A)

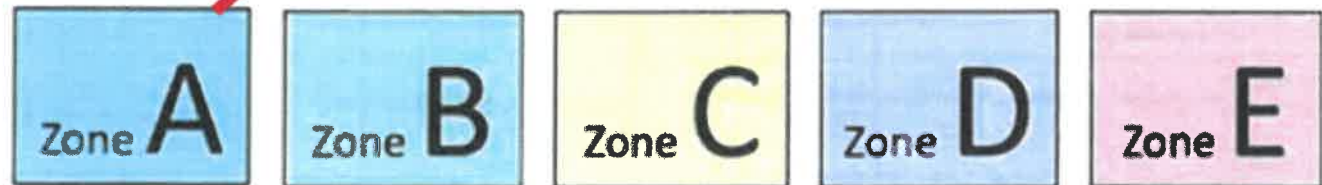

In-Hall Working Zone



■ HALL 105 (ZONE A)

Hall 105

Please check your exhibition hall and zone.

- Zone A
- Zone B
- Zone C
- Zone D
- Zone E

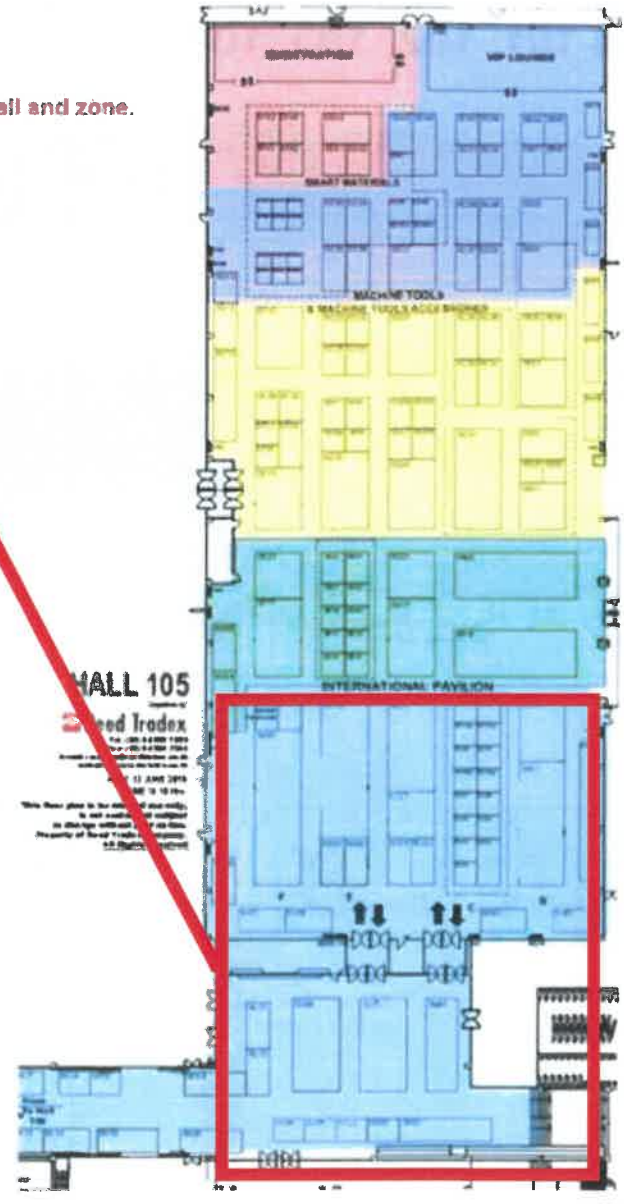

Schedule (MOVE-IN PERIOD)



Notification:

Exhibitors will come in to prepare their booth
On **19th November, 10:00-20:00**

The basic booth construction must be
accomplished by: **18, November 22:00**

MOVE-IN PERIOD: 16 - 19 NOVEMBER 2019						
98,105	Heavy machine handling <u>by Crane</u>	A	16 NOV 19	11.00 - 18.00	Contact Official On-site Handling Agents: Hall 98 contact at parking Coach Terminal Hall 105 contact at parking P1	
		B	16 NOV 19	13.00 - 18.00		
		C - D	16 NOV 19	15.00 - 18.00		
		C - D	17 NOV 19	08.00 - 14.00		
	Heavy machine handling <u>by Forklift and Hand lift</u>	A,B,C,D		16 NOV 19	13.00 - 18.00	
				17-18 NOV 19	08.00 - 18.00	
		E	19 NOV 19	08.00 - 12.00		
	Booth Construction	A,B	16 NOV 19	14.00 - 22.00	Contact Security Officer: At outdoor parking P3 <u>Truck is allowed to unload stuff at Loading area only.</u>	
		A,B	17 NOV 19	08.00 - 22.00		
		C,D	17 NOV 19	14.00 - 22.00		
		A,B,C,D	18 NOV 19	08.00 - 22.00		
		A,B,C,D	19 NOV 19	08.00 - 20.00		
	Booth Construction Standard Booth Decoration and Hand carry	A,B,C,D	19 NOV 19	08.00 - 22.00		
		E	19 NOV 19	15.00 - 22.00		
Electrical Power will start supplying at	A,B,C,D,E	18 NOV 19	10.00			
Final Hall Cleaning and Gang Way Carpet Commences at	A,B,C,D,E	19 NOV 19	13.00			
Security Deposit <i>(Not available on 16-18 NOV 19)</i>	A,B,C,D,E	19 NOV 19	18.00	Contact Security Counter Hall 99 and 103		
Exhibition Halls Closing Time	A,B,C,D,E	16-19 NOV 19	22.00			

Schedule (SHOW DAY PERIOD)



SHOW DAY PERIOD (20-23 November 2019)	DATE	TIME
Exhibition Hours	20-23 NOV 19	10.00-18.00
Exhibition Halls opened for Exhibitors	20 NOV 19	08.00-19.00
	21-22 NOV 19	09.00-19.00
	23 NOV 19	09.00-02.00

TEAR-DOWN PERIOD (23-24 November 2019)	DATE	TIME
Dismantle Booth Structure	23 NOV 19	18.00-02.00
	24 NOV 19	08.00-18.00

Perspectives (HALL 98)

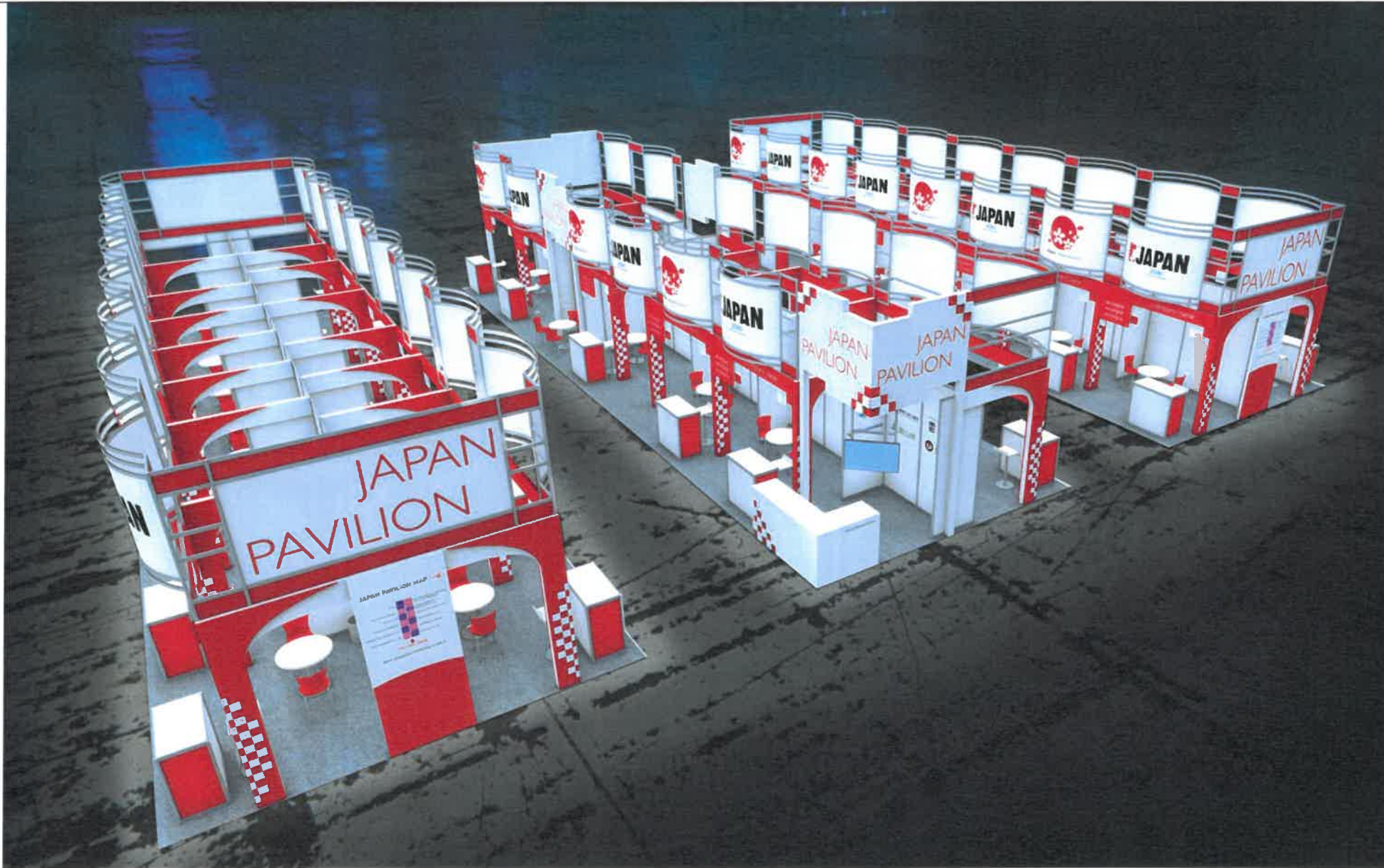

*イメージパースです。実際のレイアウトとは一部異なる場合がございます。

The perspective is an image of design, so there might be some inconsistency with the actual layout.

Perspectives (HALL 105)

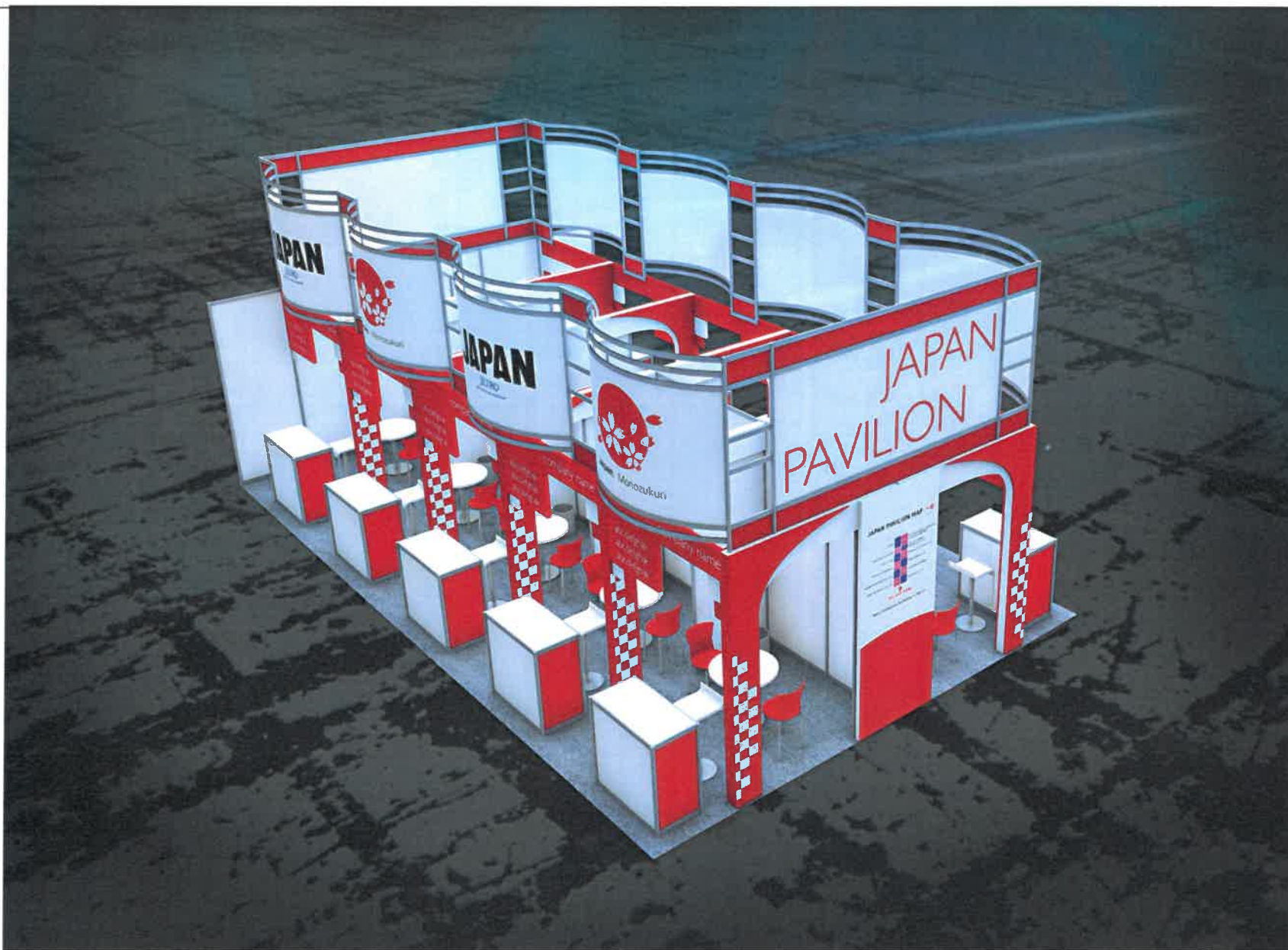

*イメージパースです。実際のレイアウトとは一部異なる場合がございます。

The perspective is an image of design, so there might be some inconsistency with the actual layout.

floor plan

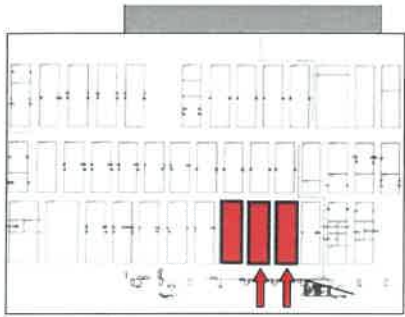

HALL 9B

	小間数/QTY	面積/SQM
JETROエリア JETRO AREA	Including OFFICE Area	18m ²
9m ² 小間 9SQM	26小間 26 Booth	234m ²
6m ² 小間 6SQM	16小間 16 Booth	96m ²
TOTAL		348m²

Block 1 / Block 3	カーペット / グレー Carpet: Gray	120m x 2
Block 2 AH01-AH08	カーペット / グレー Carpet: Gray	60m x 1
Block 2 AH09-AH14	カーペット / グレー Carpet: Gray	48m x 1
合計		348m²

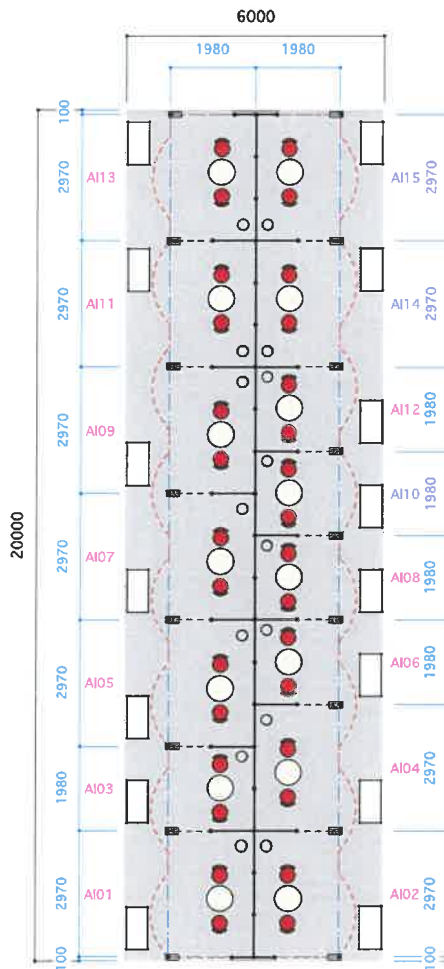

Block-3

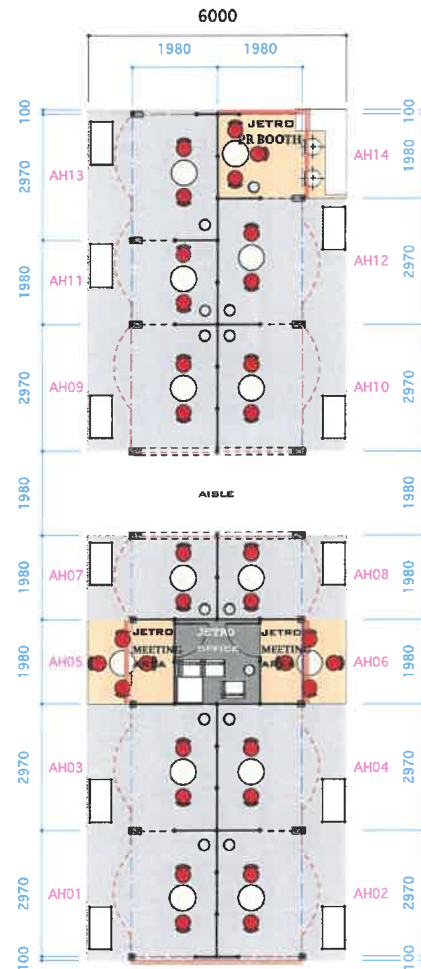

Block-2

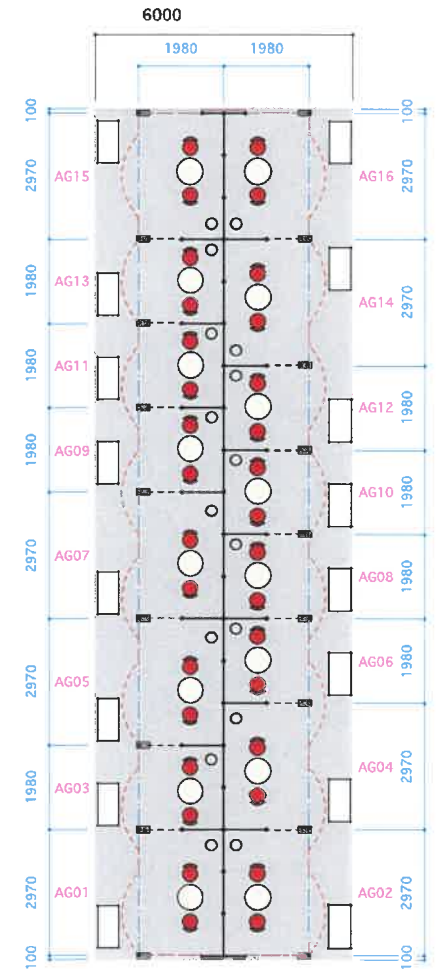

Block-1

SOUTH GATE

Project	METALEX 2019 / JETRO 様			Item	平面図 Floorplan	Date	2019.09.10 2019.09.13 2019.09.17	Sheet No.	01
Place	Bangkok International Trade & Exhibition Centre (BITEC)	Date	Session	2019.11.20~11.23	Drawn	R.HARUTA	Scale	1:120	
		Construction							

ceiling plan

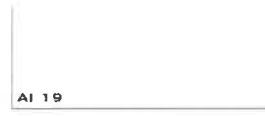

AF

オクタノルムシステムR-beam/2800φ System (Octanorm)

オクタノルムシステムbeam System (Octanorm)

	上物monozukuriサイン upper structure "monozukuri"	x22 pcs
	上物JAPANサイン upper structure "JAPAN"	x21 pcs
	9mブース社名板 company nameplate	x26 pcs
	6mブース社名板 company nameplate	x16 pcs

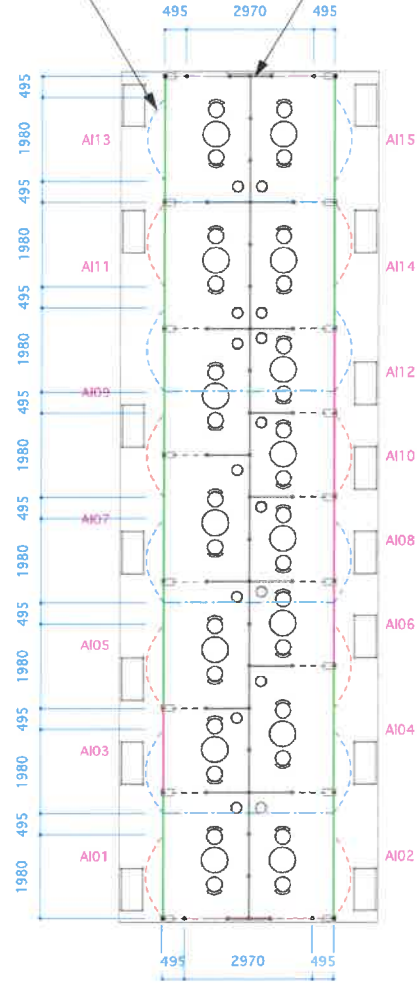

Block-3

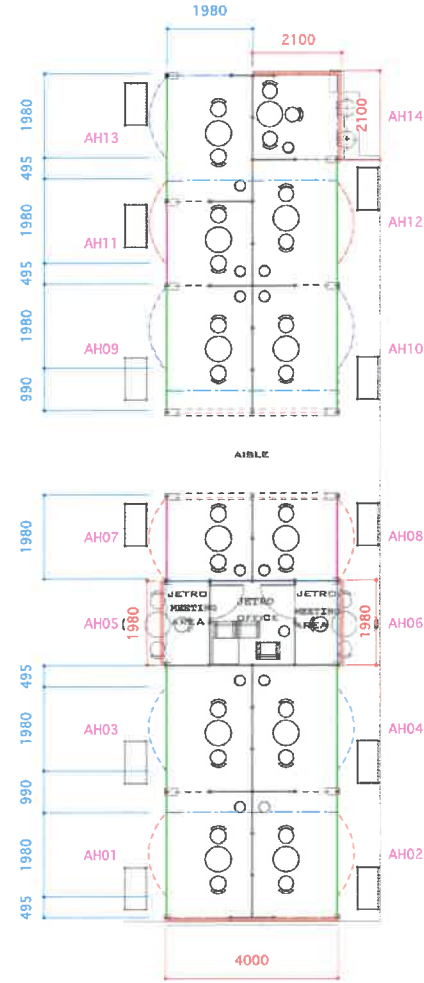

Block-2

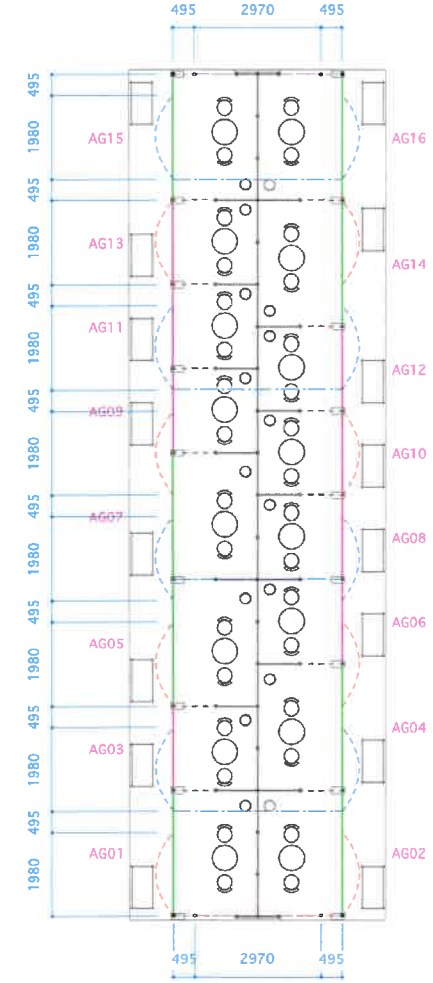

Block-1

AF

Project	METALEX 2019 / JETRO 様		Item	天井伏図 Ceiling plan		Date	2019.09.10 2019.09.13 2019.09.17	Sheet No.	02	
Place	Bangkok International Trade & Exhibition Centre (BITEC)		Session	2019.11.20~11.23		Drawn	R.HARUTA	Scale		1:120
			Construction							

electric plan 1



AF

	70w HIDスポットライト 70w HID spot light	x15 pcs
--	--------------------------------------	---------

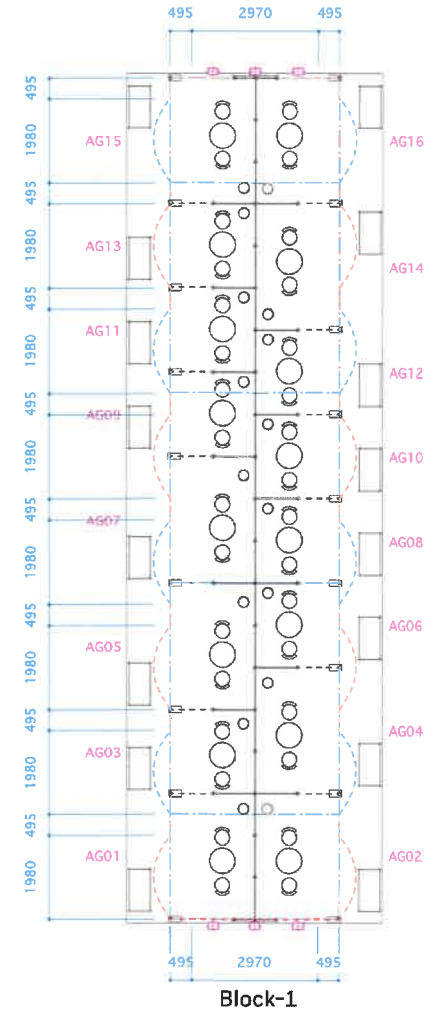
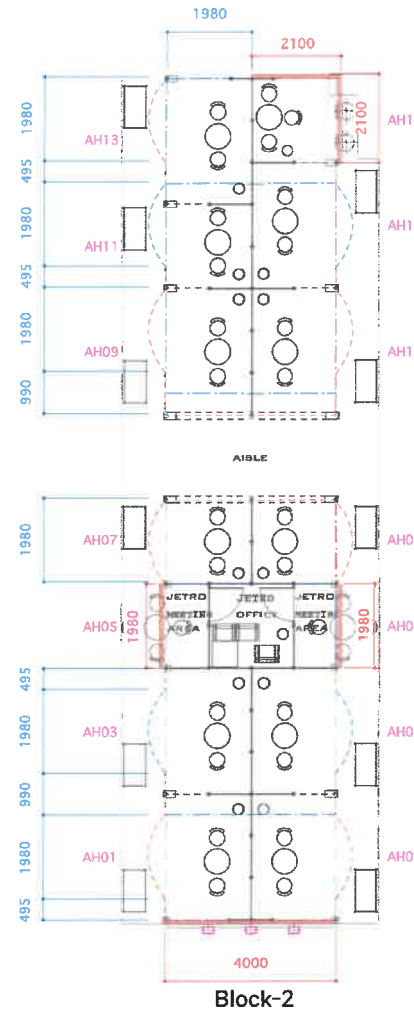
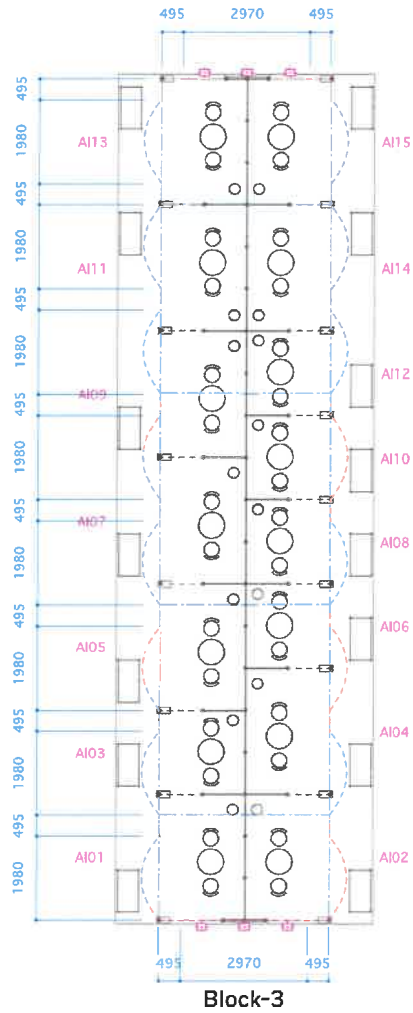

AF

Project	METALEX 2019 / JETRO 様			Item	上部照明 Upper frame lightings	Date	2019.09.10 2019.09.13 2019.09.17	Sheet No.		
	Place	Bangkok International Trade & Exhibition Centre (BITEC)	Date			Session	2019.11.20~11.23		Construction	Drawn

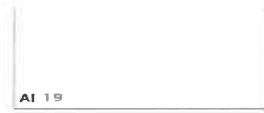

AF

	70w HIDスポットライト 70w HID spot light	x126 pcs
	ミニスポットライト mini spot light	x89 pcs
	電源 500w outlet	x47pcs

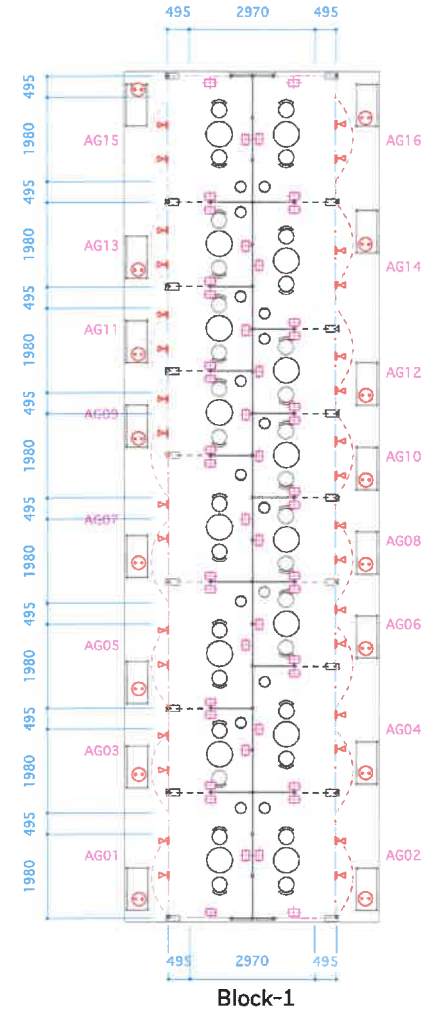
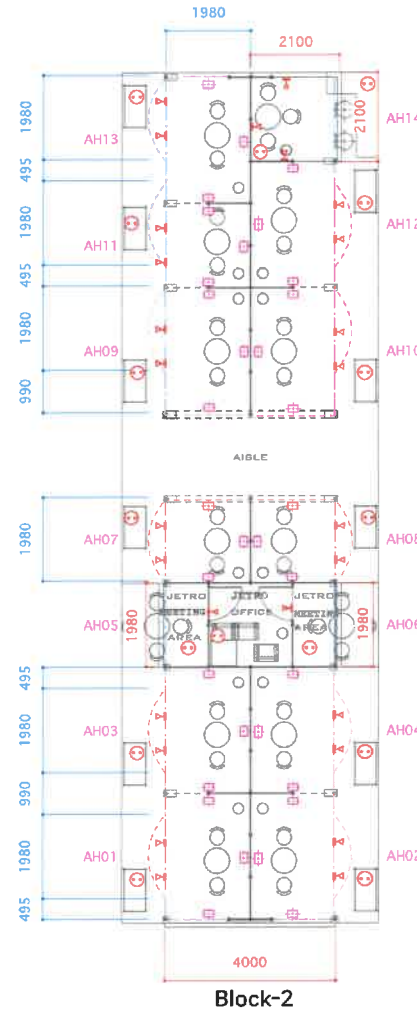
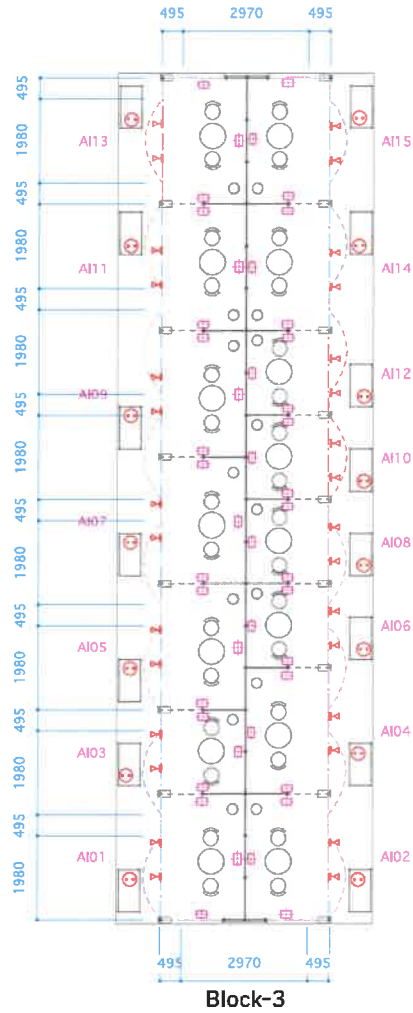

AF

Project	METALEX 2019 / JETRO 様		Item	ブース内照明+電源 Booth electrical equipment	Date	2019.09.10 2019.09.13 2019.09.17	Sheet No.	04
Place	Bangkok International Trade & Exhibition Centre (BITEC)	Date	Session 2019.11.20~11.23 Construction	Drawn	R. HARUTA	Scale	1:120	

Arch detail 1

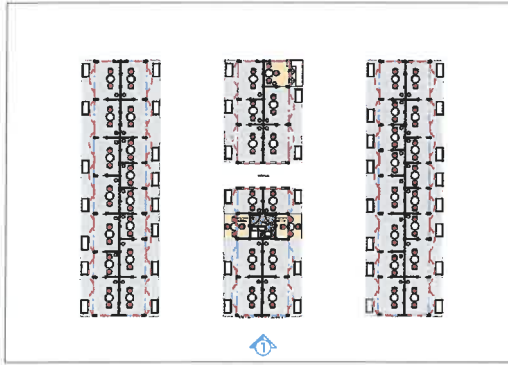

JETRO arch development 1

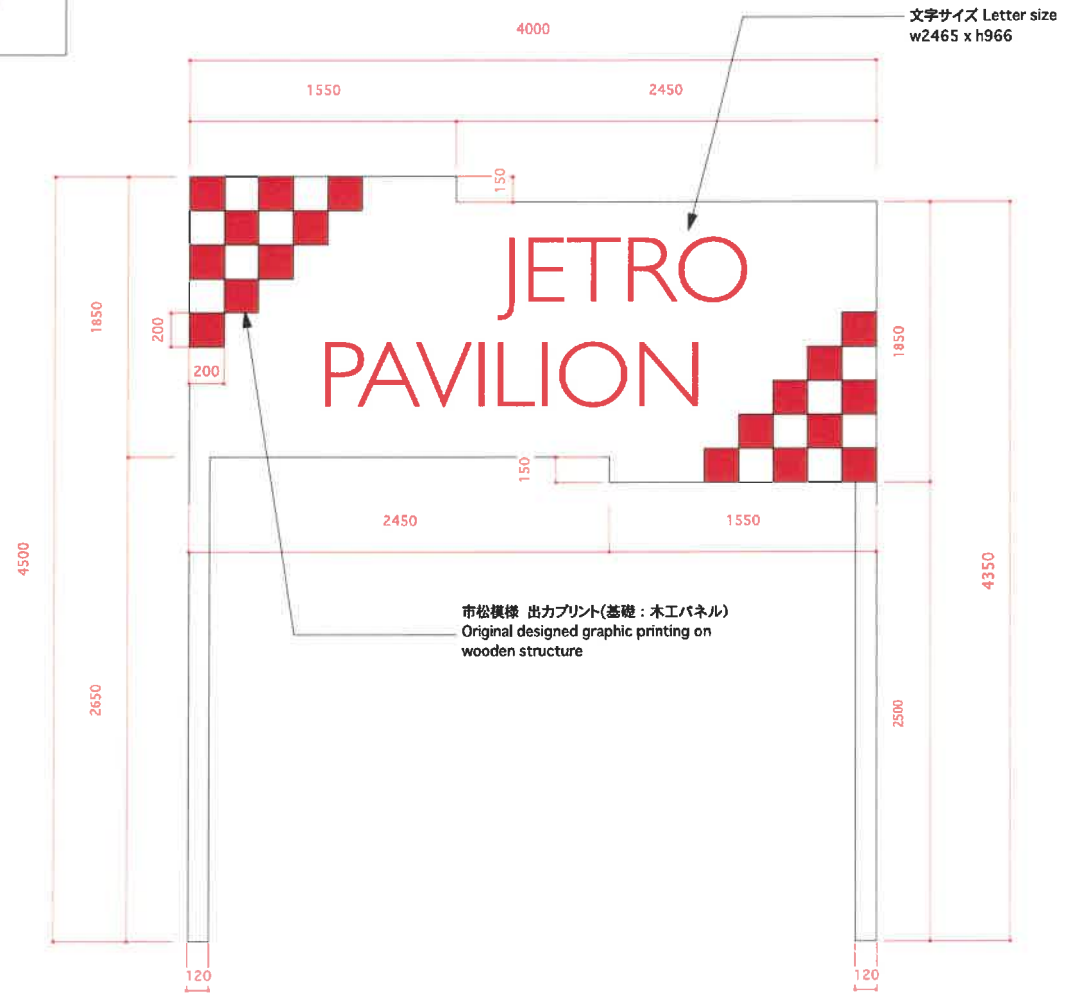

Project	METALEX 2019 / JETRO 様			Item	Date		Sheet No.	
	Place	Bangkok International Trade & Exhibition Centre (BITEC)	Date		Session	2019.11.20~11.23		2019.09.10 2019.09.13 2019.09.17
			Construction	木アーチ詳細1 Wooden Arch 1	Drawn	R.HARUTA	Scale	1:40

Arch detail 2

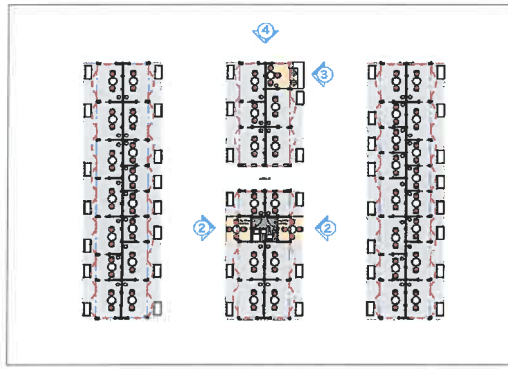

JETRO arch development 2



JETRO arch 2

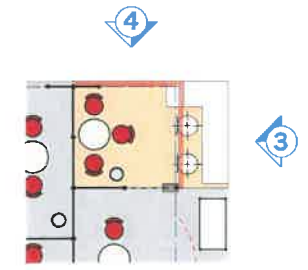

JETRO arch 3

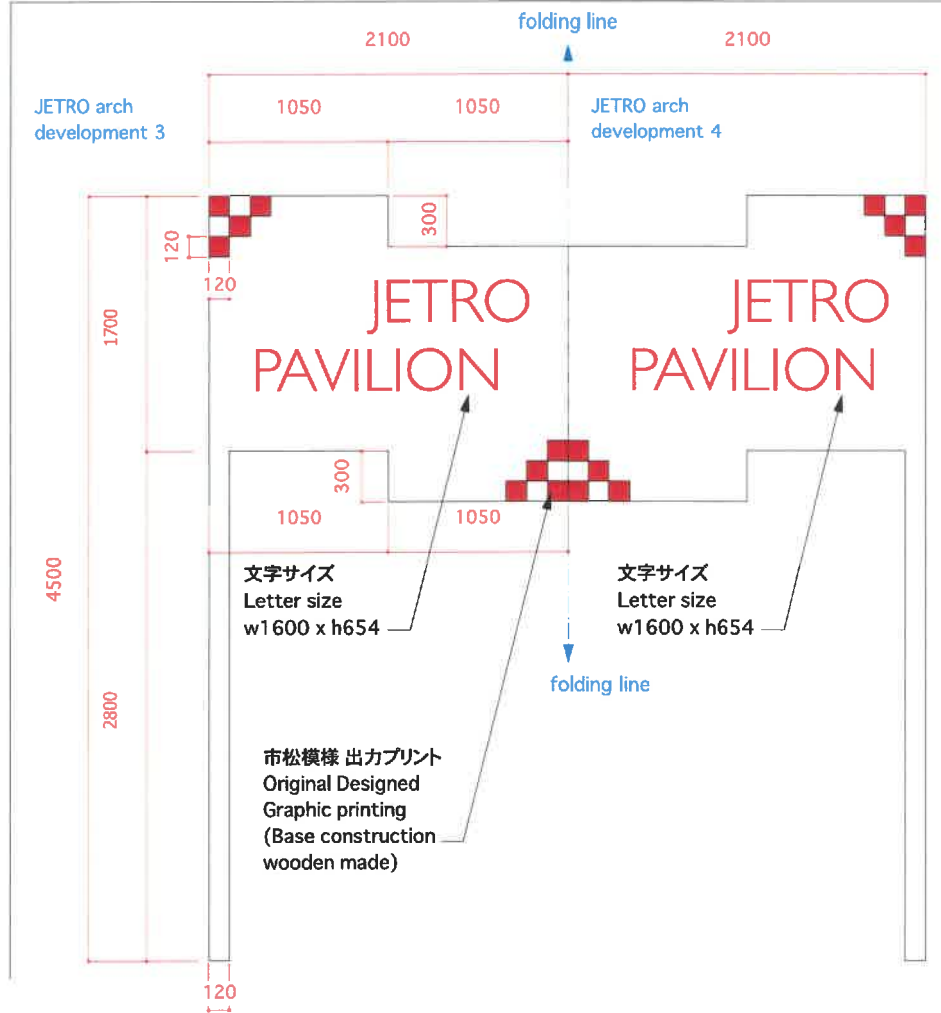

Project	METALEX 2019 / JETRO 様			Item	Date		Sheet No.	
	Place	Bangkok International Trade & Exhibition Centre (BITEC)	Date		Session	2019.11.20~11.23		Construction
				木アーチ群細2 Wooden Arch 2	Drawn	R.HARUTA	Scale	1:40

side panel cover + company name detail

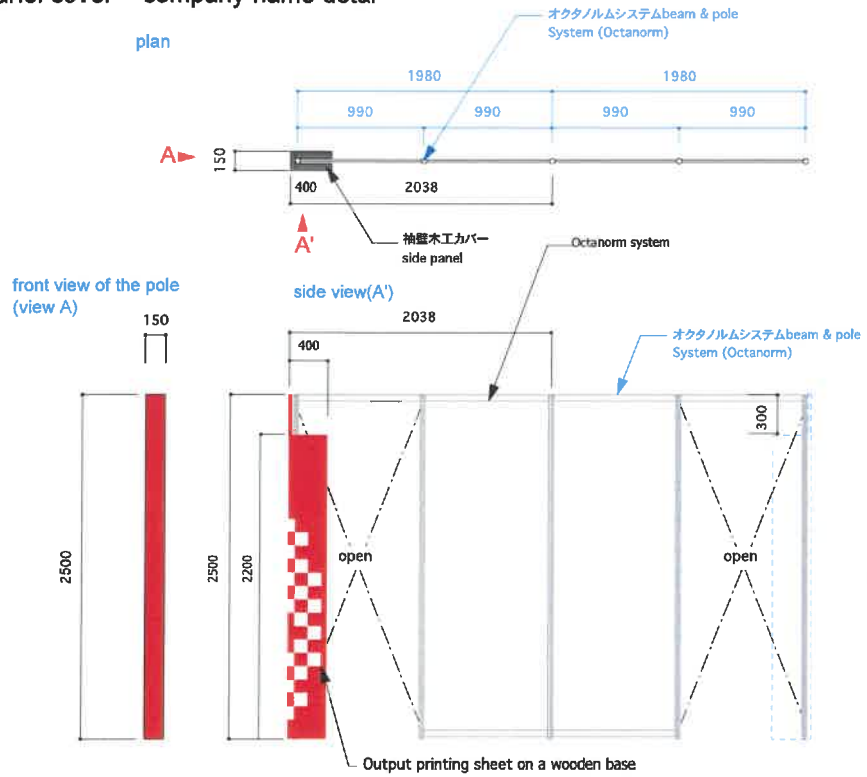
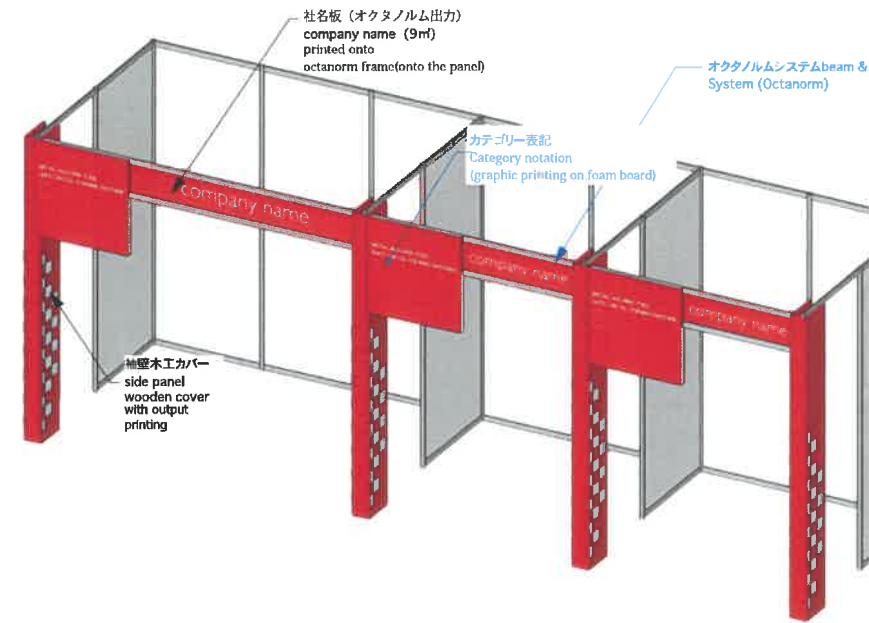
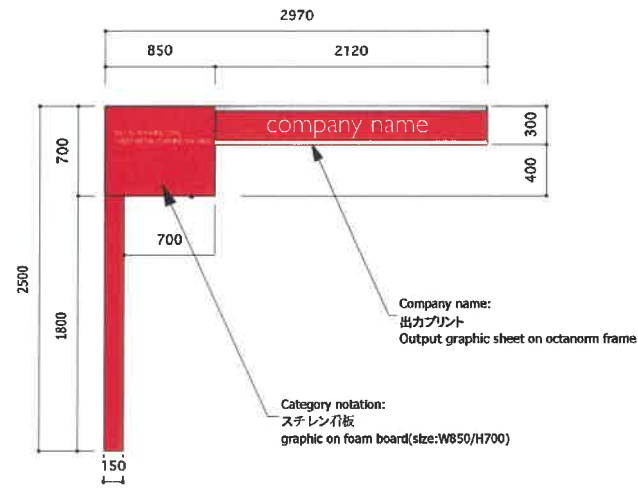

image sketch



front (9m)



front (6m)

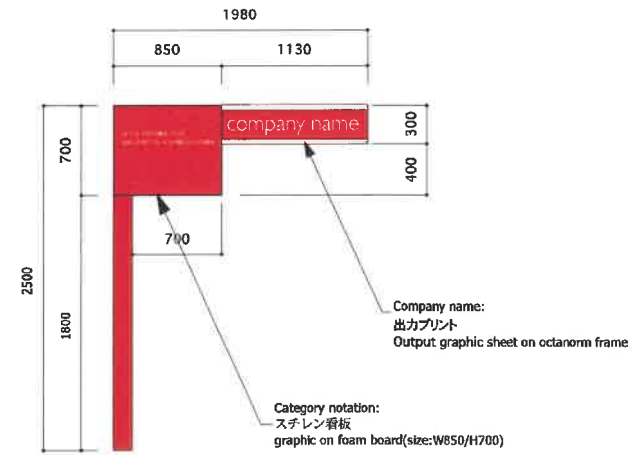

Project	METALEX 2019 / JETRO 様			Item	Date		Sheet No.
	Place	Bangkok International Trade & Exhibition Centre (BITEC)	Date/Session		2019.11.20~11.23	Drawn	
				Construction	Scale		1:40
					Company Name Details		

JETRO AREA monitor detail

plan

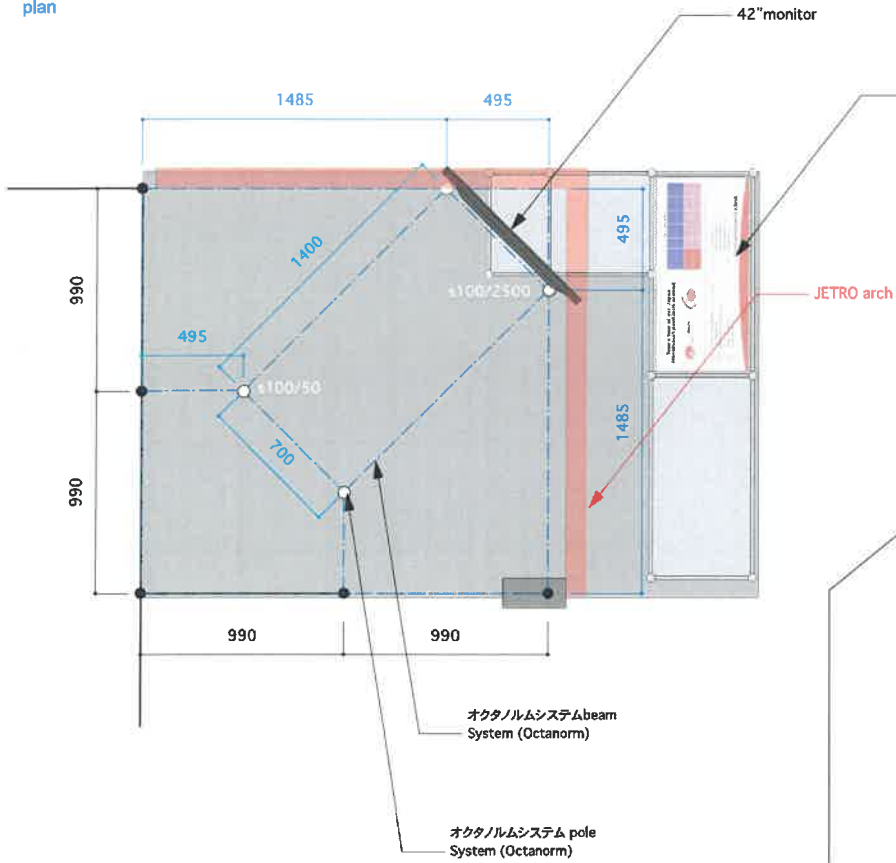

image sketch

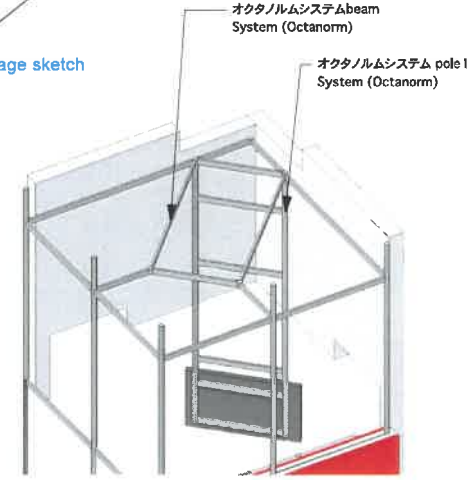
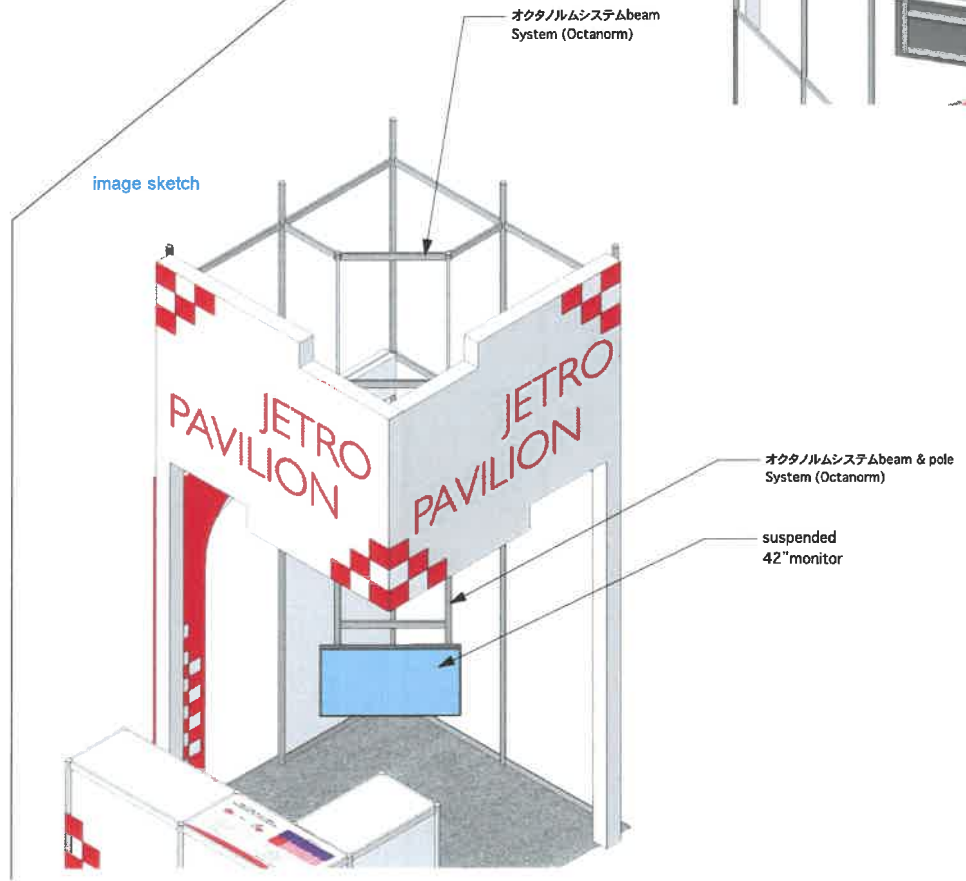

image sketch



Project	METALEX 2019 / JETRO 様			Item	Date 2019.09.10 - 2019.09.13 2019.09.17		Sheet No.
	Place	Bangkok International Trade & Exhibition Centre (BITEC)	Date/Session		2019.11.20~11.23	Drawn	
				モニター詳細	Monitor details		11

JETRO AREA (PR Booth) detail

Booth Equipment:

- Monitor (42in Hanging from the upper structure) 1nos
- Bar Stool 2nos
- Reception counter (Octanorm system made) 1set
- Round Table(φ600) 1nos
- Chairs (Stackable) 3nos (color: red will be preferable)
- Trash box 1nos

Electrical equipment

- Mini spotlight (100W) 3nos
- Outlet (220V/50hz/single phase) 2nos

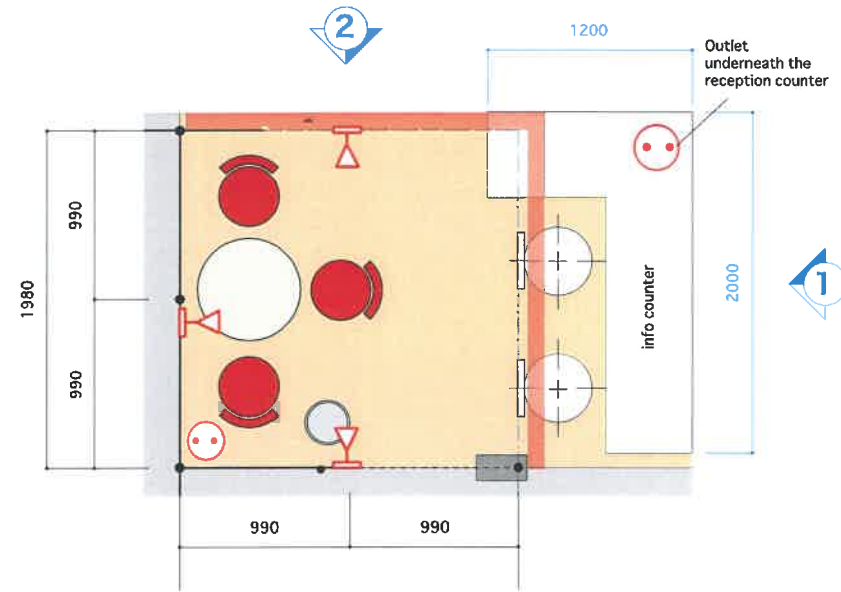
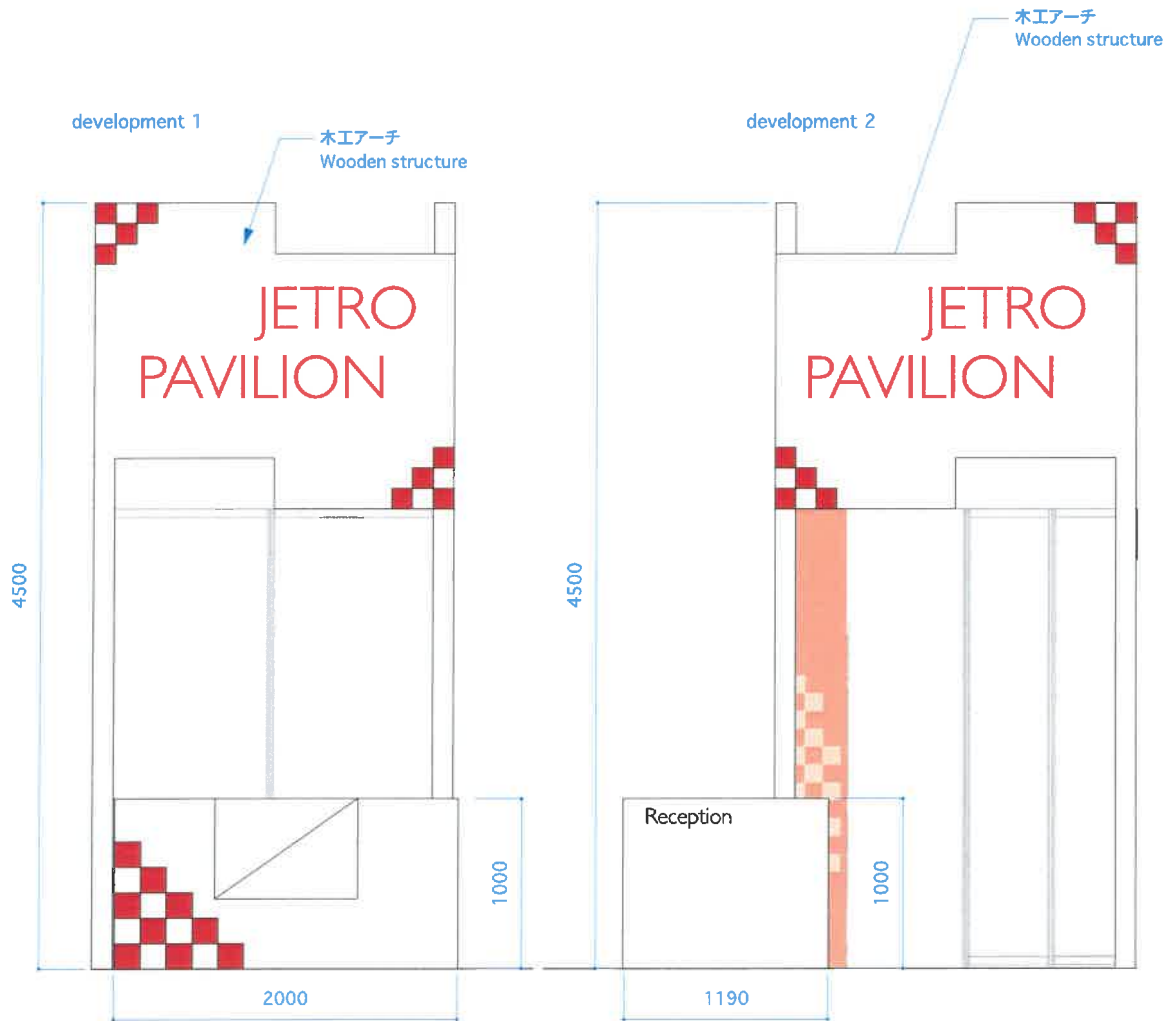

Project	METALEX 2019 / JETRO 様		Item	JETROエリア JETRO AREA		Date	2019.09.10 2019.09.13 2019.09.17		Sheet No.	12
	Place	Bangkok International Trade & Exhibition Centre (BITEC)		Date	Session		2019.11.20~11.23	Drawn		

information counter detail

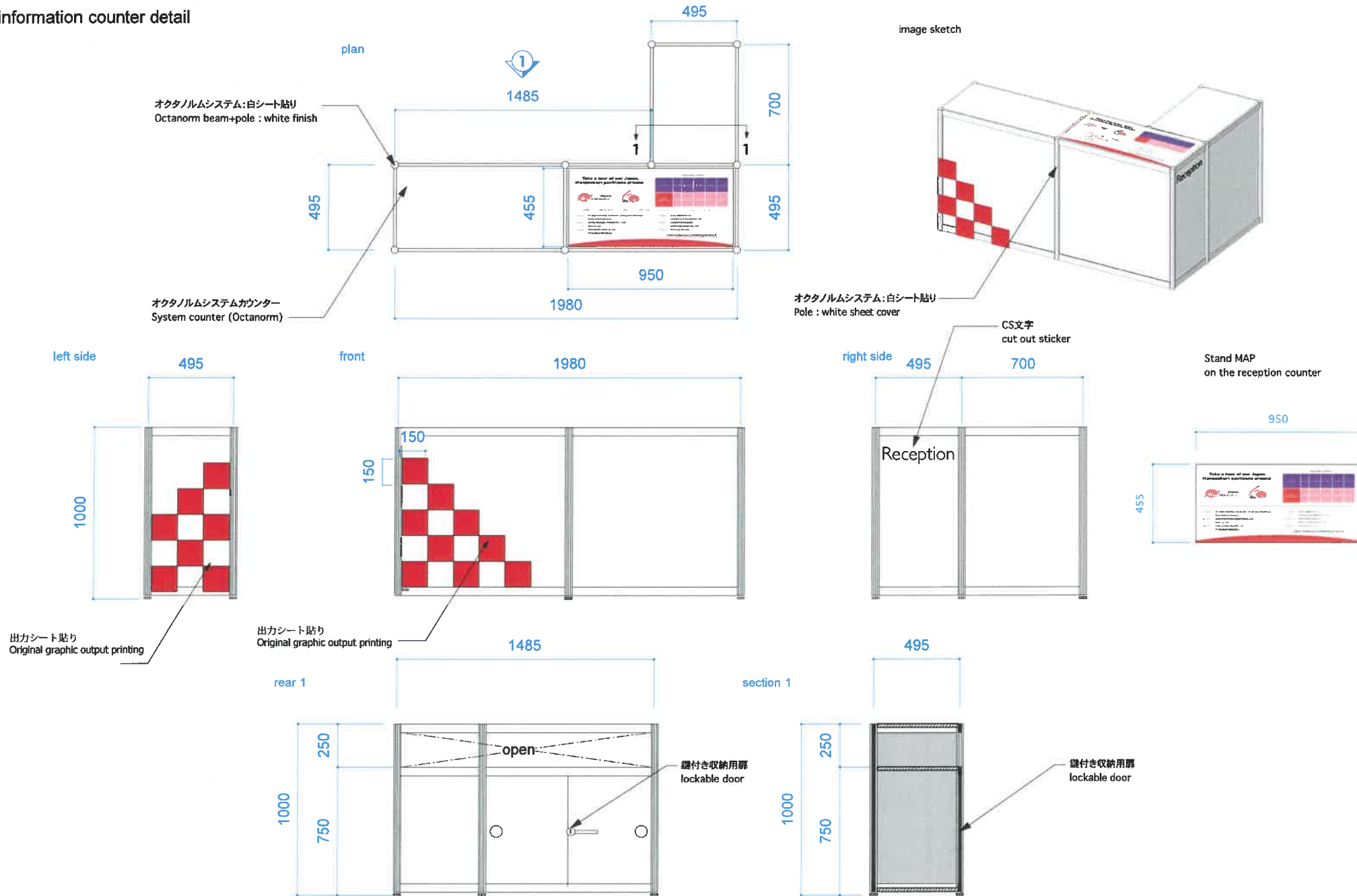

Project	METALEX 2019 / JETRO 様		Item	INFO 詳細 Reception Counter details		Date	2019.09.10 2019.09.13 2019.09.17	Sheet No.	13
	Place	Bangkok International Trade & Exhibition Centre (BITEC)		Date	2019.11.20~11.23	Drawn	R. HARUTA		

Floor plan

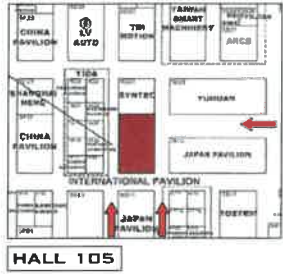

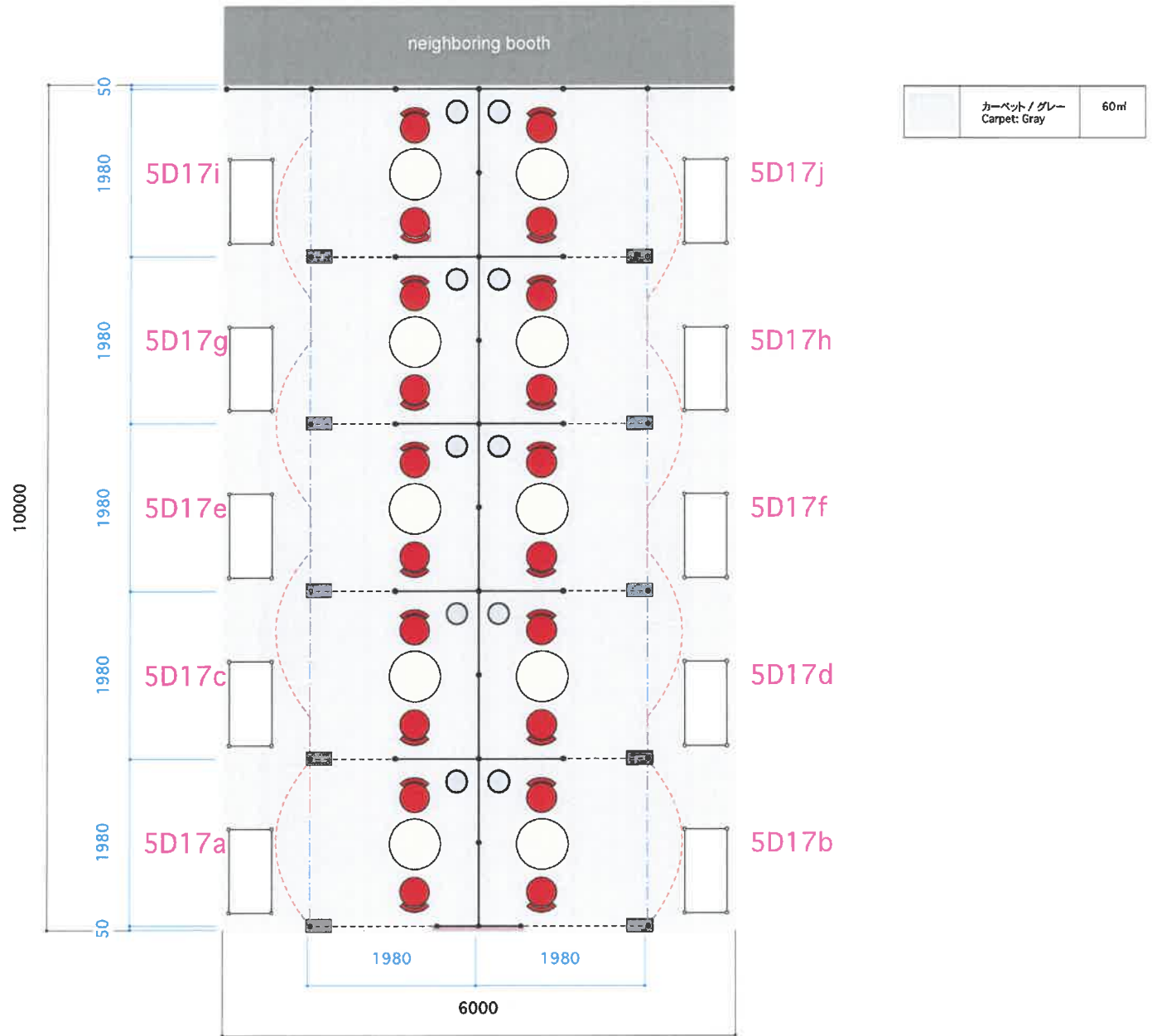

小間数 QTY		面積 SQM
6㎡小間 6 SQM	10小間 10 Booth	60㎡
		Total: 60㎡

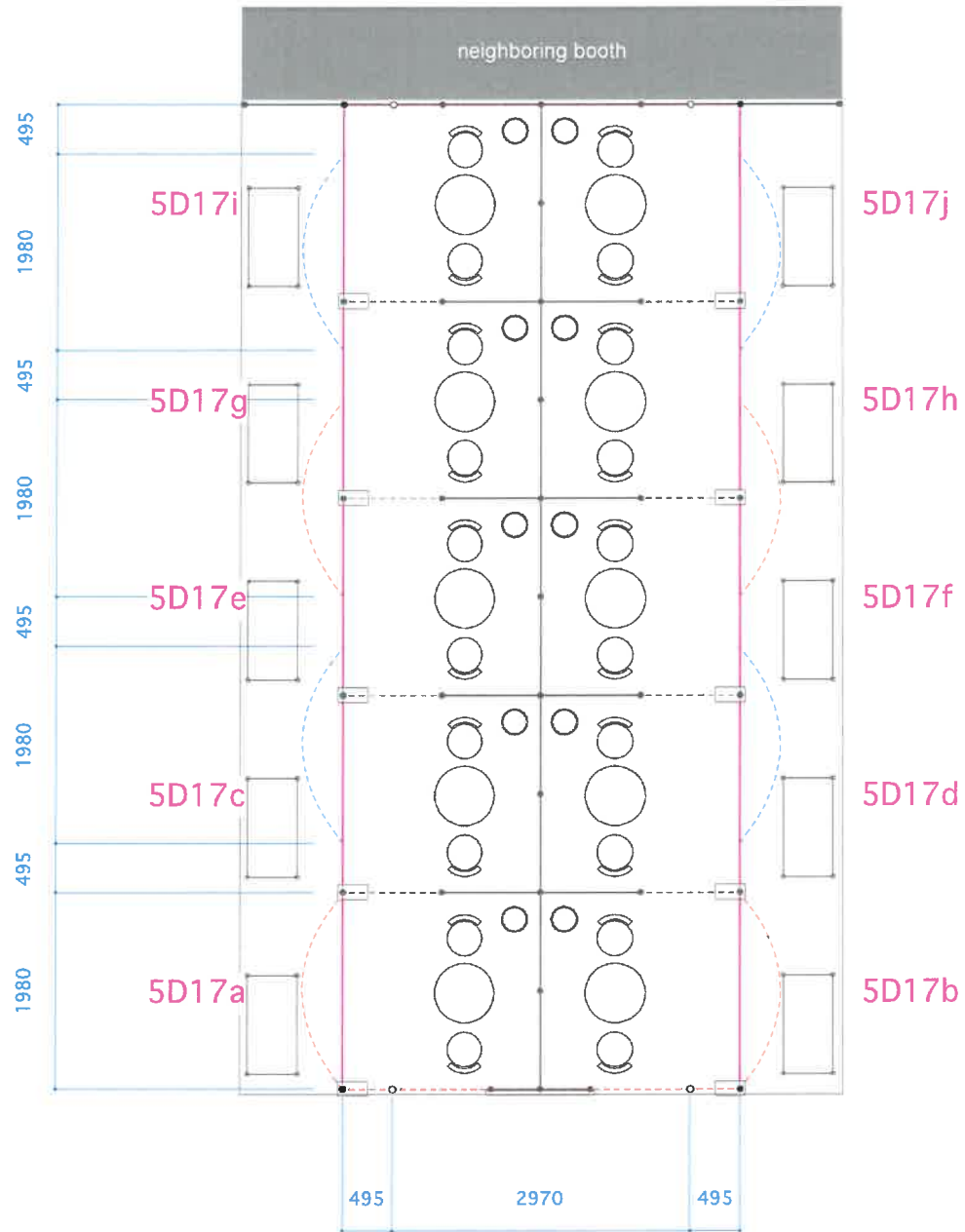

Project	METALEX 2019 / JETRO 様		Item	平面図2 Floor plan 2		Date	2019.09.10 2019.09.13 2019.09.17		Sheet No.	14
	Place	Bangkok International Trade & Exhibition Centre (BITEC)		Construction	2019.11.20~11.23		Drawn	R.HARUTA		

Ceiling plan



	上物monozukuriサイン upper structure "monozukuri"	x4 pcs
	上物JAPANサイン upper structure "JAPAN"	x4 pcs
	6mブース社名板 company nameplate	x10 pcs

Project	METALEX 2019 / JETRO 様			Item	天井図2 Ceiling plan 2		Date	2019.09.10 2019.09.13 2019.09.17	Sheet No.	15
	Place	Bangkok International Trade & Exhibition Centre (BITEC)	Date		Session	2019.11.20~11.23	Construction	Drawn		

electric plan 1(for upper frame)

	70w HIDスポットライト 70w HID spot light	x3 pcs
---	--------------------------------------	--------

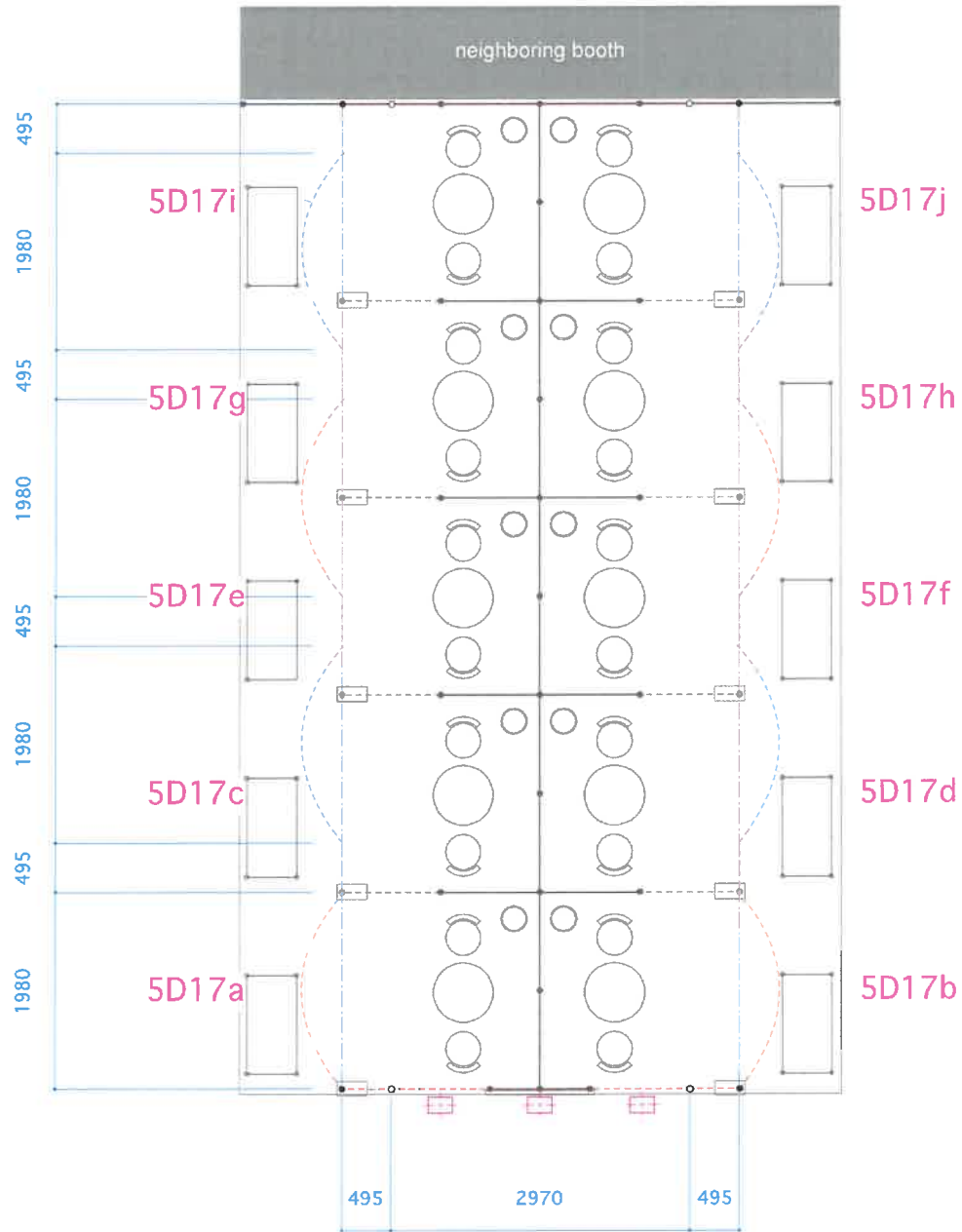

	Project		METALEX 2019 / JETRO 様		Item	上部照明		Date	2019.08.10	Sheet No.	
	Place		Bangkok International Trade & Exhibition Centre (BITEC)			Upper frame		Electrical plan	2019.08.13		Scale
		Date	Session				Drawn	2019.09.17			
				2019.11.20~11.23				R. HARUTA		1:50	

electric plan 2 (For Exhibitors Booth)

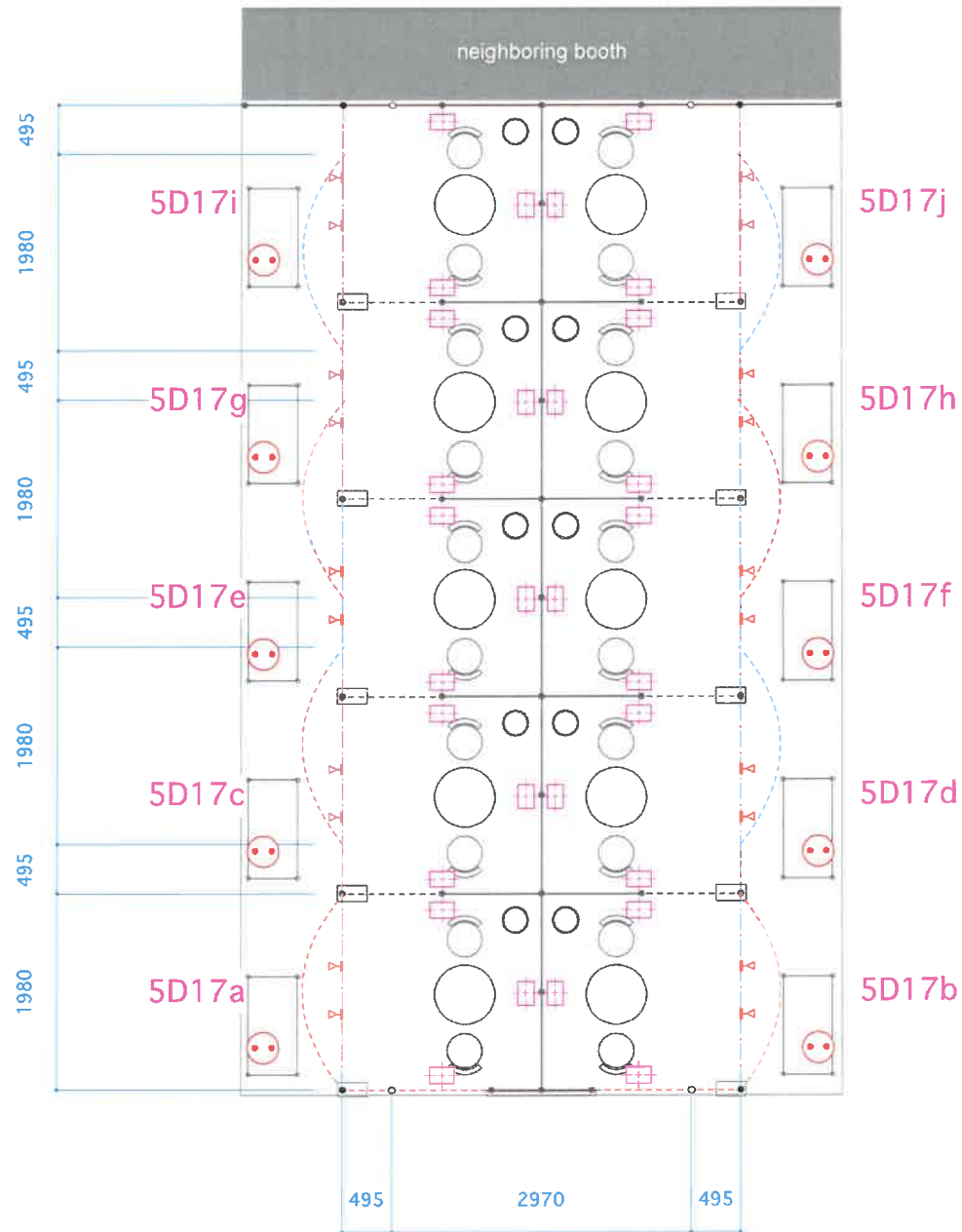

	70w HIDスポットライト 70w HID spot light	x30 pcs
	ミニスポットライト mini spot light	x20 pcs
	電源 500w Outlet	x10 pcs

Project	METALEX 2019 / JETRO 様		Item	ブース内照明+電源 Booth Lightings / Outlets		Date	2019.09.10 2019.09.13 2019.09.17		Sheet No.	17	
	Place	Bangkok International Trade & Exhibition Centre (BITEC)		Date	Session 2019.11.20~11.23		Drawn	R. HARUTA			Scale

elevation

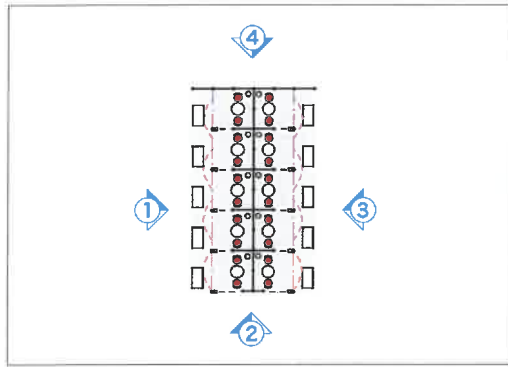

upper structure detail

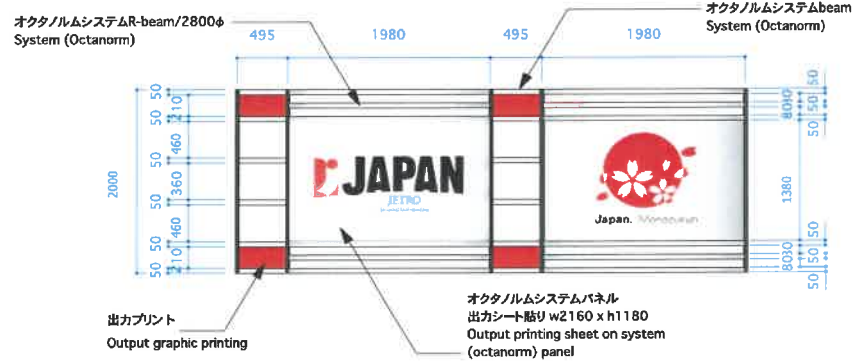

upper structure detail (end)

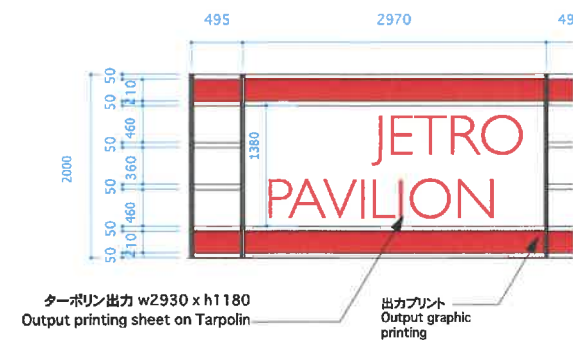

elevation 1

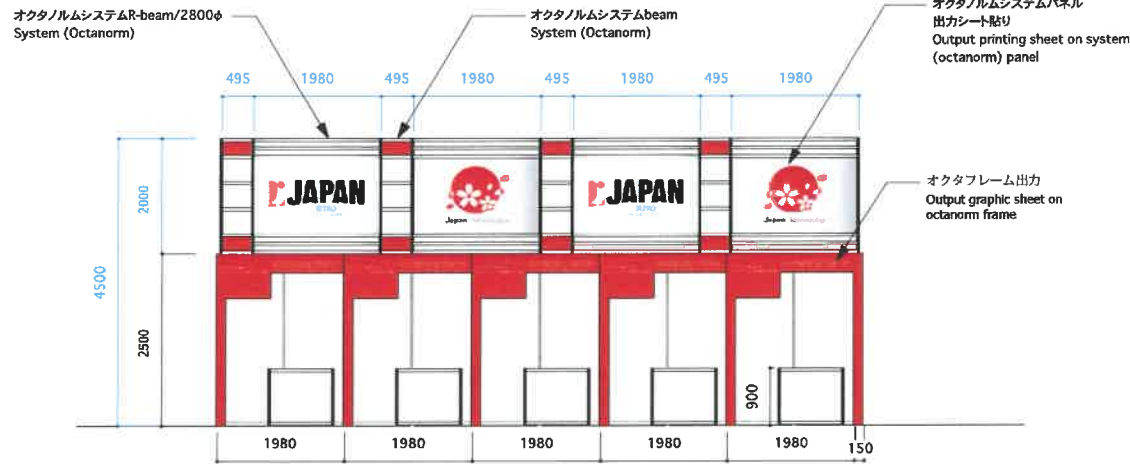

elevation 2

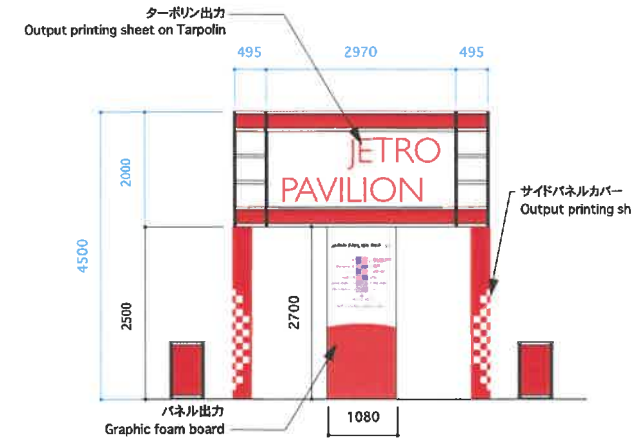

elevation 3

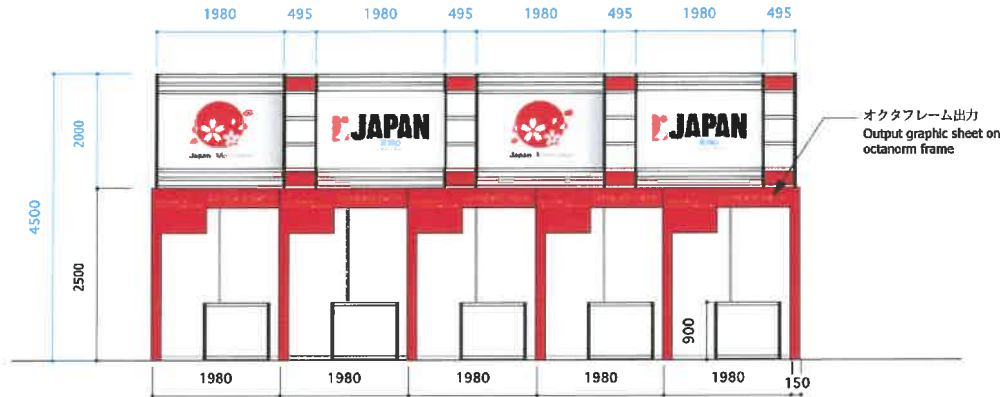

elevation 4

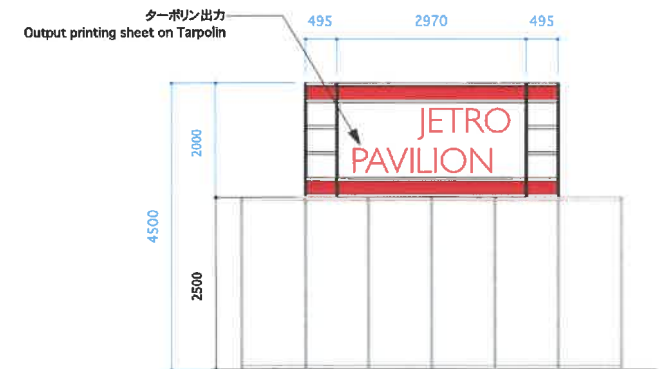

Project	METALEX 2019 / JETRO 様			Item	Date 2019.08.10 2019.08.13 2019.08.17		Sheet No.
	Place	Bangkok International Trade & Exhibition Centre (BITEC)	Date/Session		2019.11.20~11.23	Construction	
					全体立面図4 Elevation plan 4		18

9 sqm booth details

2970

9 sqm booth x26 stand

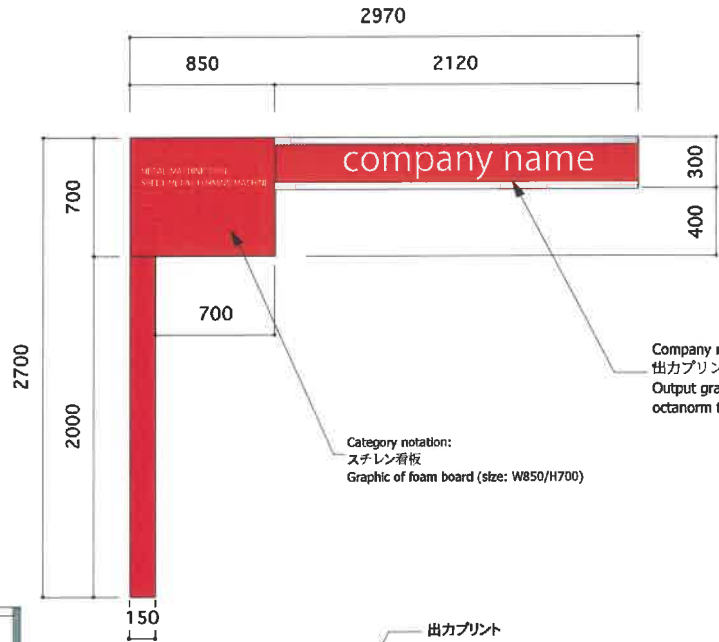
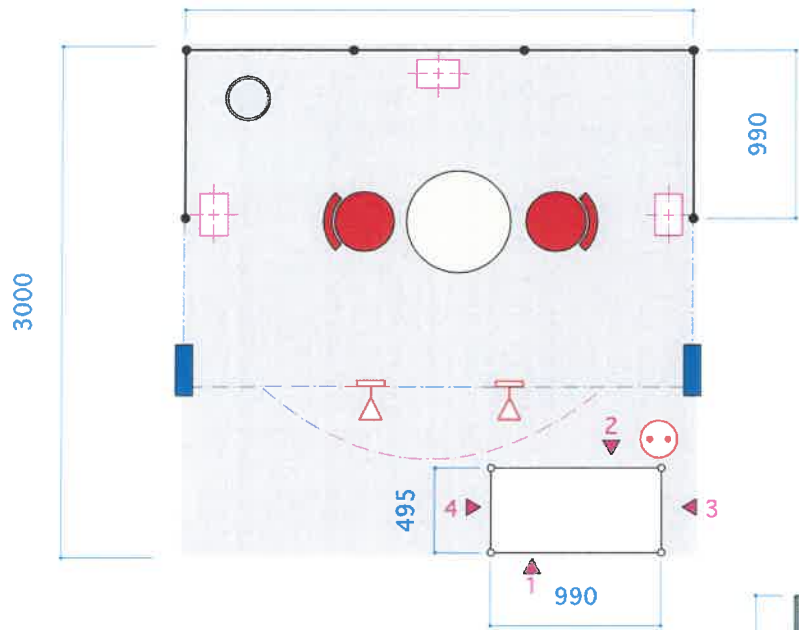

Company name:
出カプリント
Output graphic sheet on
octanorm frame

Category notation:
ステン看板
Graphic of foam board (size: W850/H700)

出カプリント
Output graphic printing
on a wooden structure

Category notation:
ステン看板
Graphic of foam board (size: W850/H700)

鍵付き収納用扉
lockable door

オクタノルムシステムパネル(白)
(octanorm)panel

オクタノルムシステムポール
(octanorm)pole

	Lockable Cabinet (w990 x d495 x h900)	x1nos
	trash box	x1nos
	Round table	x1nos
	Stackable chair Color: Red will be preferable	x2nos
	70w HIDスポットライト 70w HIDspot light	x3pcs
	ミニスポットライト mini spot light	x2pcs
	コンセント Outlet	x1pcs

※ Location is subject to change

Project	METALEX 2019 / JETRO 様		Item	Date		Sheet No.
	Place	Bangkok International Trade & Exhibition Centre (BITEC)		Date	2019.09.10 2019.09.13 2019.09.17	
Date	Session	2019.11.20~11.23	9ブース詳細 9SQM Booth Details	Drawn	R. HARUTA	19
Place	Construction			Scale	1:80	

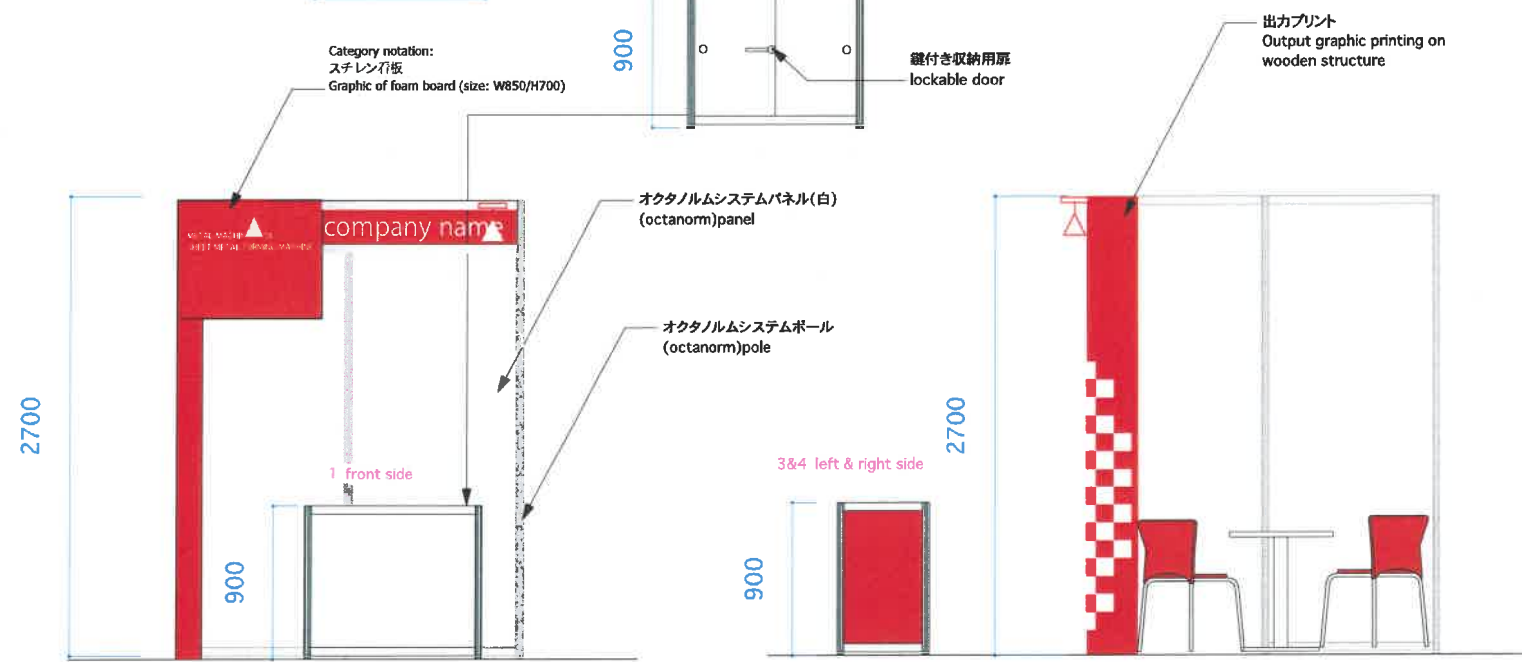
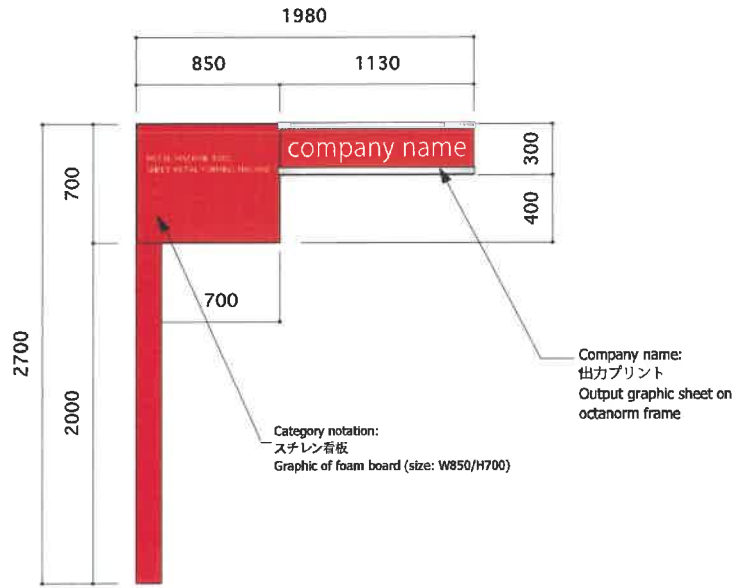
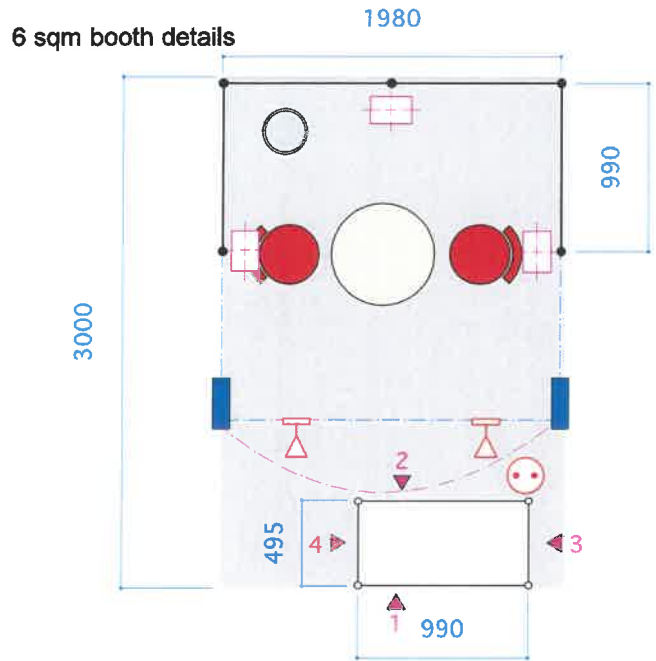

	Lockable cabinet (w990 x d495 x h900)	x1nos
	trash box	x1nos
	Round table	x1nos
	Stackable chair Color: Red will be preferable	x2nos
	70w HIDスポットライト 70w HIDspot light	x3pcs
	ミニスポットライト mini spot light	x2pcs
	コンセント Outlet	x1pcs

※ Location is subject to change

Project	METALEX 2019 / JETRO 様		Item	6mブース詳細 6 SQM Booth Details		Date	2019.09.10 2019.09.13 2019.09.17		Sheet No.	20	
	Place	Bangkok International Trade & Exhibition Centre (BITEC)		Date	2019.11.20~11.23		Drawn	R.HARUTA			Scale

JETRO AREA

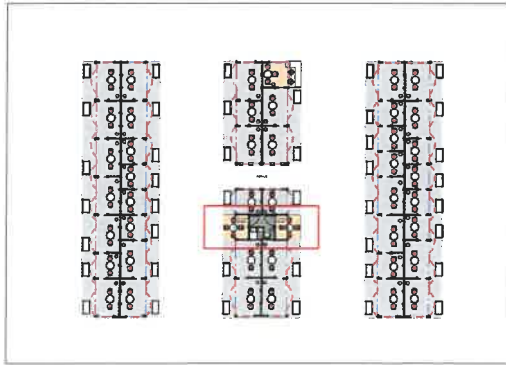

JETRO AREA consists from:

- 1) JETRO OFFICE (Located in the center part)
- 2) JETRO MEETING AREA (located on both sides)

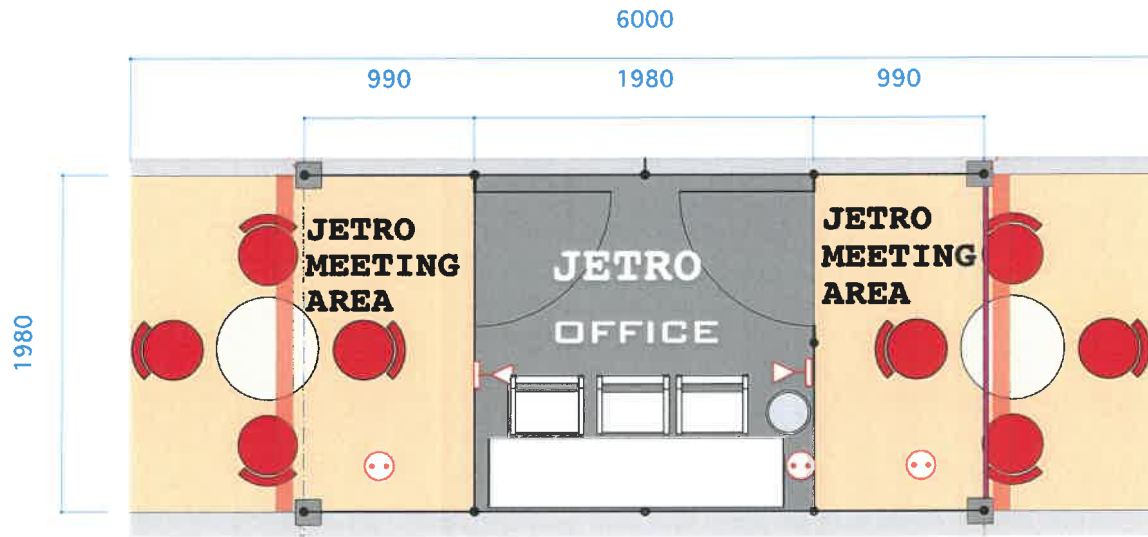

Extra 3 folding chair will be place near the desk area(folded)

	Meeting table (w1800 x d450xh750)	x1nos
	trash box	x1nos
	Round table	x2nos
	Stackable chair Color: Red will be preferable	x8nos
	Folding chair	x6nos

	ミニスポットライト mini spot light	x2pcs
	コンセント Outlet	x3pcs

Project	METALEX 2019 / JETRO 様		Item	JETROオフィス詳細 JETRO OFFICE		Date	2019.05.10 2019.05.13 2019.09.17		Sheet No.	21	
	Place	Bangkok International Trade & Exhibition Centre (BITEC)		Date	Session 2019.11.20~11.23 Construction		Drawn	R. HARUTA			Scale

上部サイン 1 w2160 x h1380
Booth upper frame signage 1

x25pcs



サイン 2 w2160 x h1380
Booth upper frame signage 2

x26pcs



上部エンドサイン
Booth upper frame (end part)
Printed onto Tarpolin

w2930 x h1380

x8pcs



JETROアーチ 大 ロゴサイン w2465 x h966
Logo for the Arch structure(Large)
As for the end upper frame for "Block-2"

x1pc



JETROアーチ 小 ロゴサイン w1600 x h654
Logo for the Arch structure (small)
as for the "JETRO AREA" Reception upper
frame

x2pcs



ブースMAP
Stand MAP

x1pc

w950 x h455



Attached onto the top
of the
reception counter
(octanorm)

エンドサイン
Booth end panels

x6p

w1080 x h2500

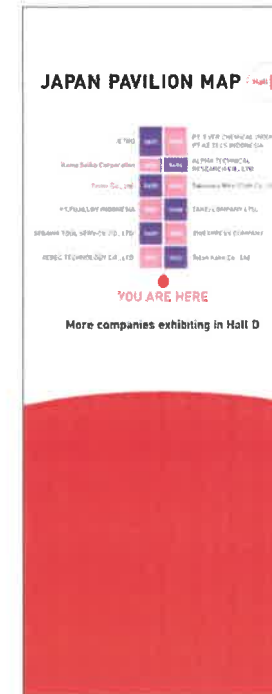

カテゴリ表記 w850 x h700
Category notation (foam board)

x52pcs



社名板 (出力シート) w1980 x h270 Company
name sheet (mounted onto octanorm frame) panel

company name width: 1130

company name

x26pcs

社名板 (出力シート) w2970 x h270
Company name sheet (mounted onto octanorm frame) panel

company name width: 1130

company name

x26pcs

	Project		METALEX 2019 / JETRO 様		Item	サイン		Date	2019.09.10 2019.09.13 2019.09.17		Sheet No.	
	Place	Bangkok International Trade & Exhibition Centre (BITEC)	Date	2019.11.20~11.23		signage Instruction	Drawn		R. HARUTA	Scale		1:80
			Session	Construction								

Booth Equipment List

*Dimensions are all in millimeter



Exhibitors Booth (per each booth)

Locable Cabinet
(with a lock) *Octanorm
展示台 (鍵付き/オクタノルム)
Size: W990/D495/H900

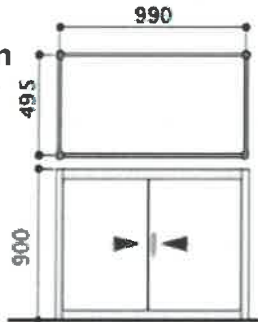

1 nos

Round Table
丸テーブル
Size: φ600
サイズ: φ600



1 nos

Stackable Chair
椅子

Color:
Red will be
preferable



2 nos

Trash Box (13L)
ゴミ箱 (13L)
Color: White



1 nos

*With 20 garbage bags as a set
*色: 白色

※ゴミ袋20枚付き

RECEPTION / JETRO PR Booth

Bar Stool
バーチェア
Size:
W440/D370/H610~840
SH500~730



2 nos

Monitor
Size: 42inch *Hanging overhead



1 set

Reception Counter

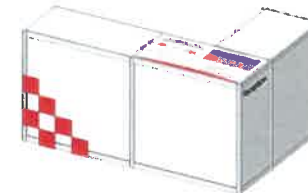

1 set



Stackable Chair
Color: Red will be preferable
3 nos

Round Table
丸テーブル
1 nos



Trash Box (13L)
ゴミ箱 (13L)
Color: White
with 20 bags for
repair 1 nos

JETRO OFFICE/ JETRO MEETING AREA

長テーブル
Long Table
Size: W1800/D450/
H750



1 nos

Folding Chair
Size: W420/D420/H730
SH430



6 nos

Trash Box (13L)
ゴミ箱 (13L)
Color: White



1 nos

*With 20 garbage bags as a set
*色: 白色

※ゴミ袋20枚付き



Stackable Chair
Color: Red will be preferable
8 nos

Round Table
丸テーブル
2 nos

